

Disk Organization: Records

Parke Godfrey

Topics for today

- How to lay out data on disk
- How to move it to memory

What are the data items we want to store?

- a salary
- a name
- a date
- a picture

What are the data items we want to store?

- a salary
- a name
- a date
- a picture

⇒ What we have available: Bytes

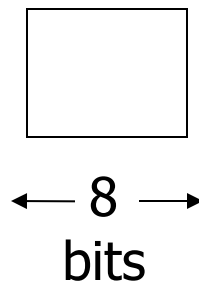

To represent:

- Integer (short): 2 bytes

e.g., 35 is

00000000	00100011
----------	----------

- Real, floating point
 n bits for mantissa, m for exponent....

To represent:

- Characters

→ various coding schemes suggested,
most popular is ASCII (Now: UTF-8)

Example:

A: 1000001
a: 1100001
5: 0110101
LF: 0001010

To represent:

- Boolean

e.g., TRUE

1111 1111

FALSE

0000 0000

- Application specific

e.g., RED → 1 GREEN → 3

BLUE → 2 YELLOW → 4 ...

To represent:

- Boolean

e.g., TRUE

1111	1111
------	------

FALSE

0000	0000
------	------

- Application specific

e.g., RED → 1 GREEN → 3

BLUE → 2 YELLOW → 4 ...

⇒ Can we use less than 1 byte/code?

Yes, but only if desperate...

To represent:

- Dates

e.g.: - Integer, # days since Jan 1, 1900

- 8 characters, YYYYMMDD

- 7 characters, YYYYDDD

(not YYMMDD! Why?)

- Time

e.g. - Integer, seconds since midnight

- characters, HHMMSSFF

To represent:

- String of characters
 - Null terminated

e.g.,

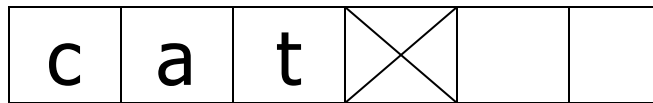

- Length given

e.g.,

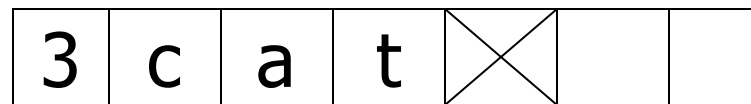

- Fixed length

To represent:

- Bag of bits

Length	Bits
--------	------

Key Point

- Fixed length items
- Variable length items
 - usually length given at beginning

Also

- Type of an item: Tells us how to interpret
(plus size if fixed)

Overview

Data Items



Records



Blocks



Files



Memory

Record - Collection of related data items (called FIELDS)

E.g.: Employee record:

name field,

salary field,

date-of-hire field, ...

Types of records:

- Main choices:
 - FIXED vs VARIABLE FORMAT
 - FIXED vs VARIABLE LENGTH

Fixed format

A **schema** (not record) contains following information

- # fields
- type of each field
- order in record
- meaning of each field

Example: fixed format and length

Employee record

- (1) E#, 2 byte integer
- (2) E.name, 10 char.
- (3) Dept, 2 byte code

Schema

55	s m i t h	02
----	-----------	----

83	j o n e s	01
----	-----------	----

Records

Variable format

- Record itself contains format
“Self Describing”

Example: variable format and length

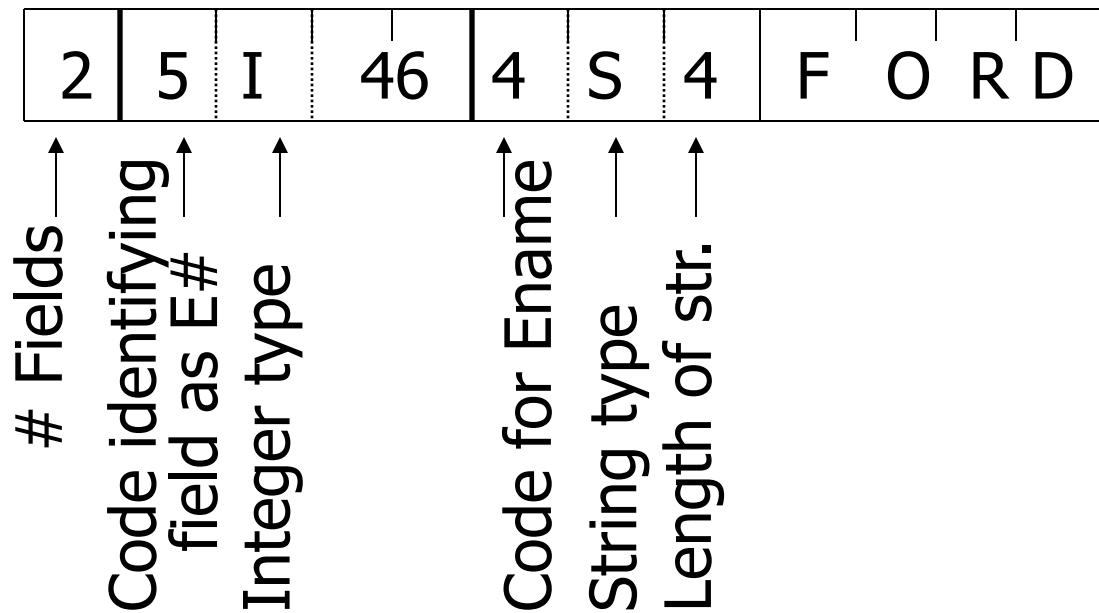

Field name codes could also be strings, i.e. TAGS

Variable format useful for:

- “sparse” records
- repeating fields
- evolving formats

.....> But may waste space...

- EXAMPLE: var format record with repeating fields

Employee → one or more → children

3	E_name: Fred	Child: Sally	Child: Tom
---	--------------	--------------	------------

Note: Repeating fields does not imply

- variable format, nor
- variable size

John	Sailing	Chess	--
------	---------	-------	----

Note: Repeating fields does not imply

- variable format, nor
- variable size

John	Sailing	Chess	--
------	---------	-------	----

- Key is to allocate maximum number of repeating fields (if not used → null)

☆ Many variants between
fixed - variable format:

Example: Include record type in record



record type record length
tells me what
to expect
(i.e., points to schema)

Record header - data at beginning
that describes record

May contain:

- record type
- record length
- time stamp
- other stuff ...

Exercise: How to store XML data?

```
<table>
<description> people on the fourth floor <\description>
<people>
  <person>
    <name> Alan <\name>
    <age> 42 <\age>
    <email> agb@abc.com <\email>
  <\person>
  <person>
    <name> Sally <\name>
    <age> 30 <\age>
    <email> sally@abc.com <\email>
  <\person>
<\people>
<\table>
```

from: Data on the Web, Abiteboul et al
--

Other interesting issues:

- Compression
 - within record - e.g. code selection
 - collection of records - e.g. find common patterns
- Encryption

Encrypting Records

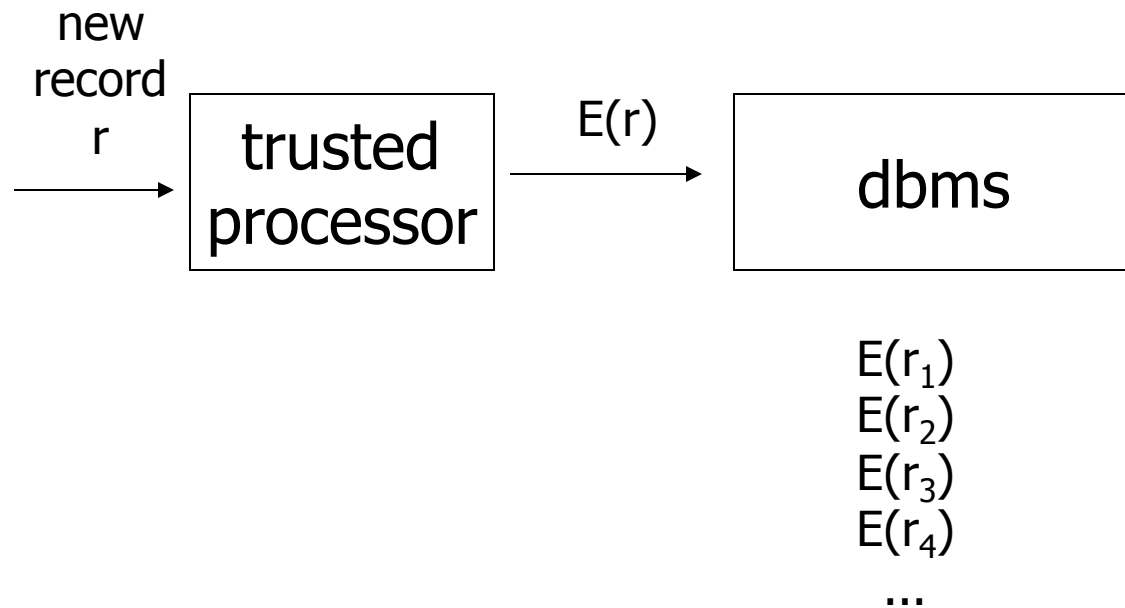

Encrypting Records

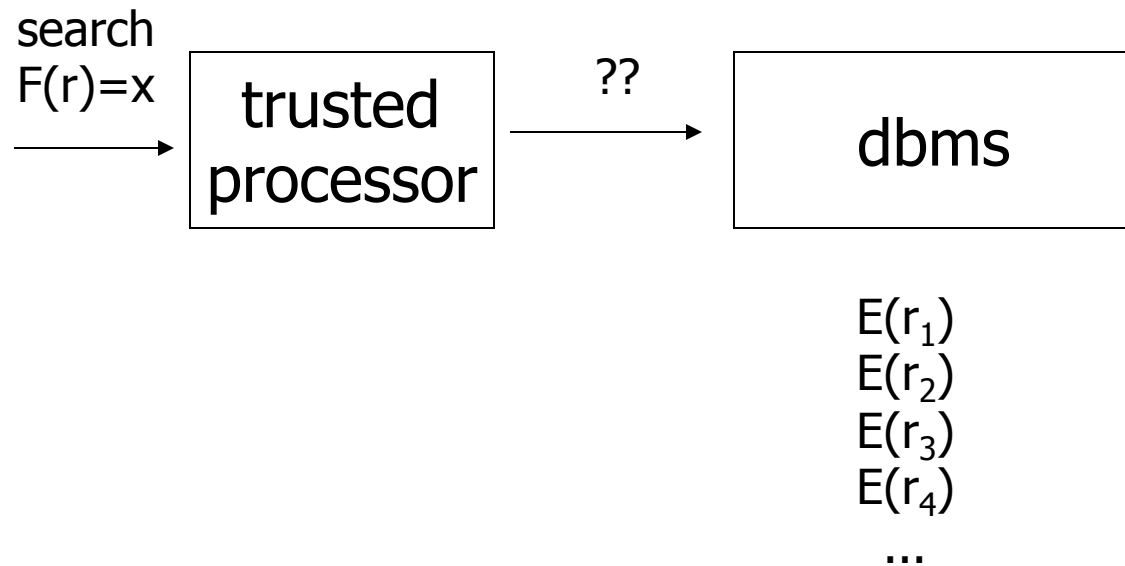

Search Key in the Clear

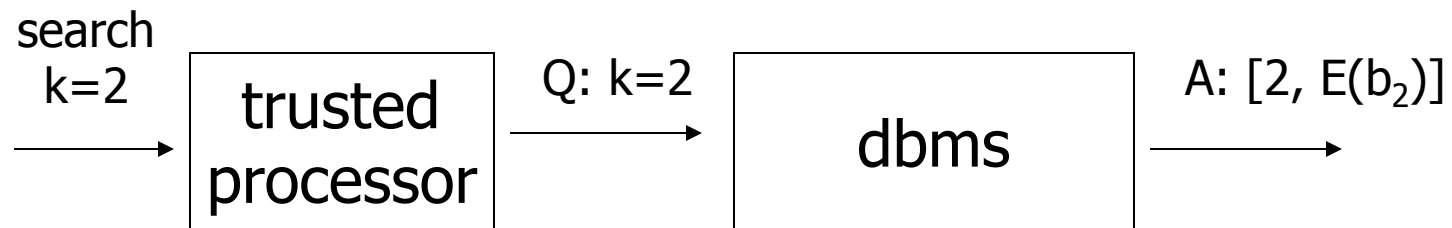

[1, E(b₁)]
[2, E(b₂)]
[3, E(b₃)]
[4, E(b₄)]

...

- each record is [k,b]
- store [k, E(b)]
- can search for records with k=x

Encrypt Key

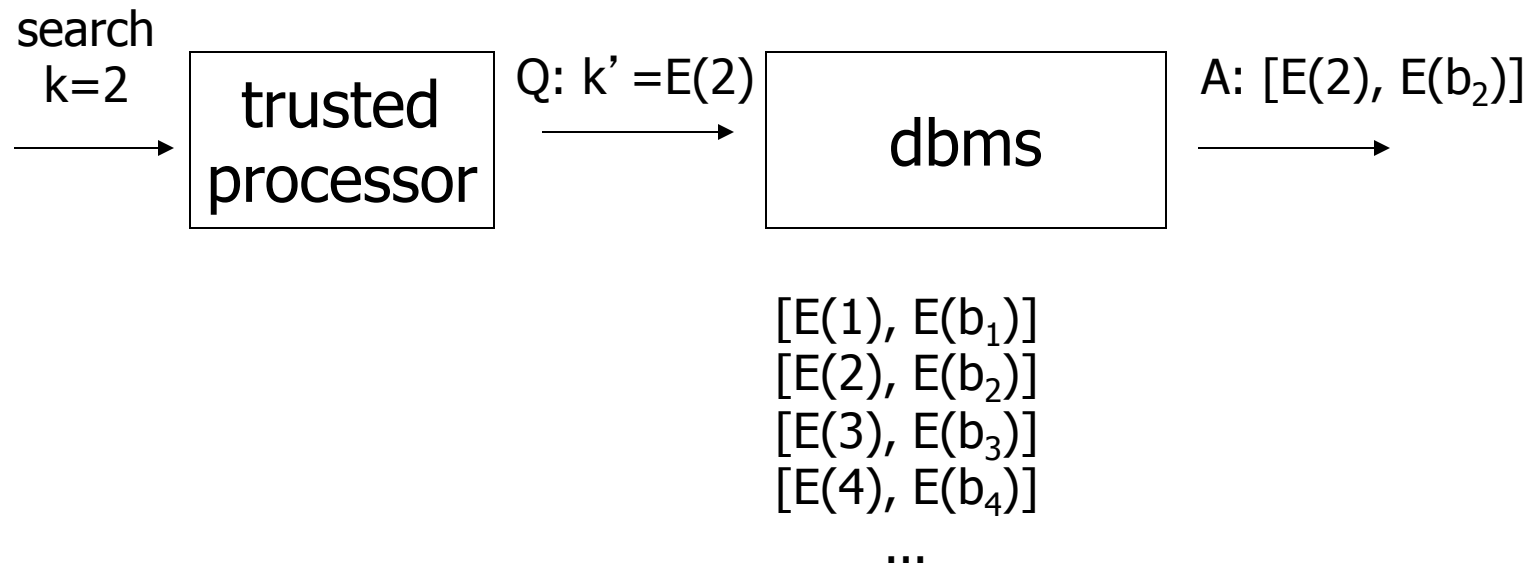

- each record is $[k, b]$
- store $[E(k), E(b)]$
- can search for records with $k=E(x)$

Issues

- Hard to do range queries
- Encryption not good
- Better to use encryption that does not always generate same cyphertext

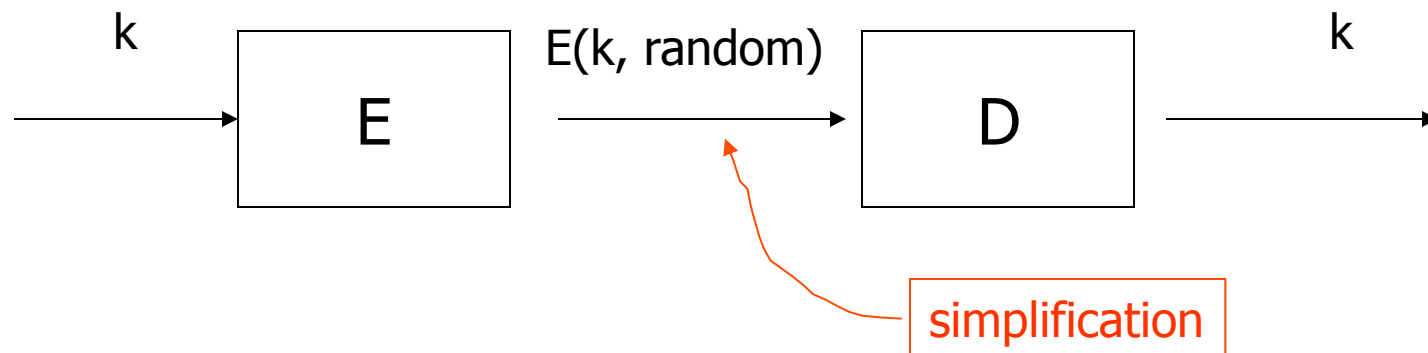

How Do We Search Now?

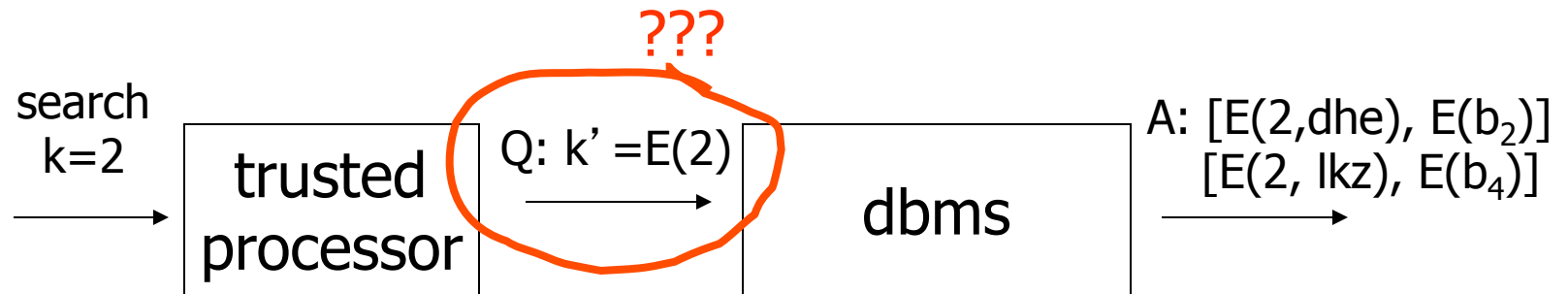

[E(1, abc), E(b₁)]
[E(2, dhe), E(b₂)]
[E(3, nft), E(b₃)]
[E(2, lkz), E(b₄)]

...

- each record is [k,b]
- store [E(k, rand), E(b)]
- can search for records with k=E(x,???)?

Solution?

- Develop new decryption function:
 $D(f(k_1), E(k_2, \text{rand}))$ is true if $k_1 = k_2$

Solution?

- Develop new decryption function:
 $D(f(k_1), E(k_2, \text{rand}))$ is true if $k_1 = k_2$

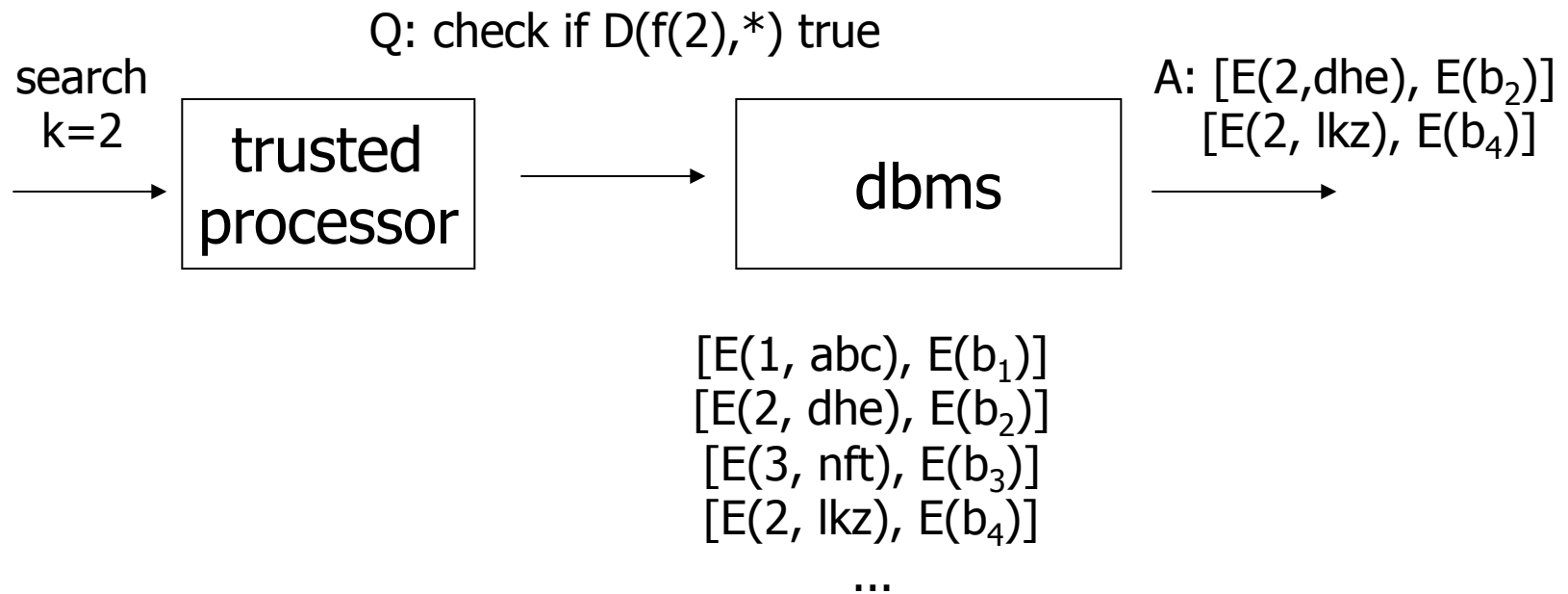

Issues?

- Cannot do non-equality predicates
- Hard to build indexes

What are choices/issues with data compression?

- Leaving search keys uncompressed not as bad
- Larger compression units:
 - better for compression efficiency
 - worse for decompression overhead
- Similar data compresses better
 - compress columns?

Next: placing records into blocks

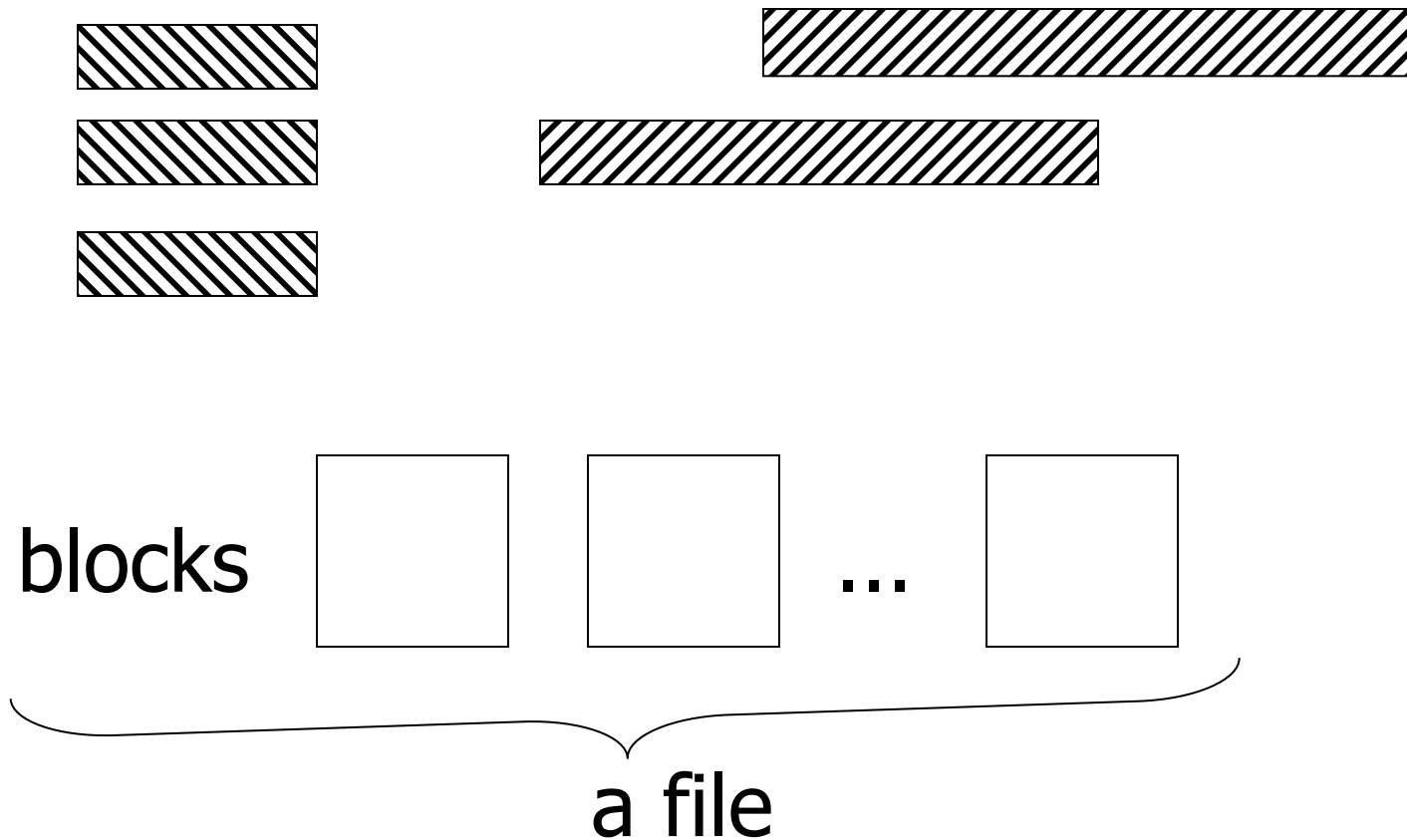

Next: placing records into blocks

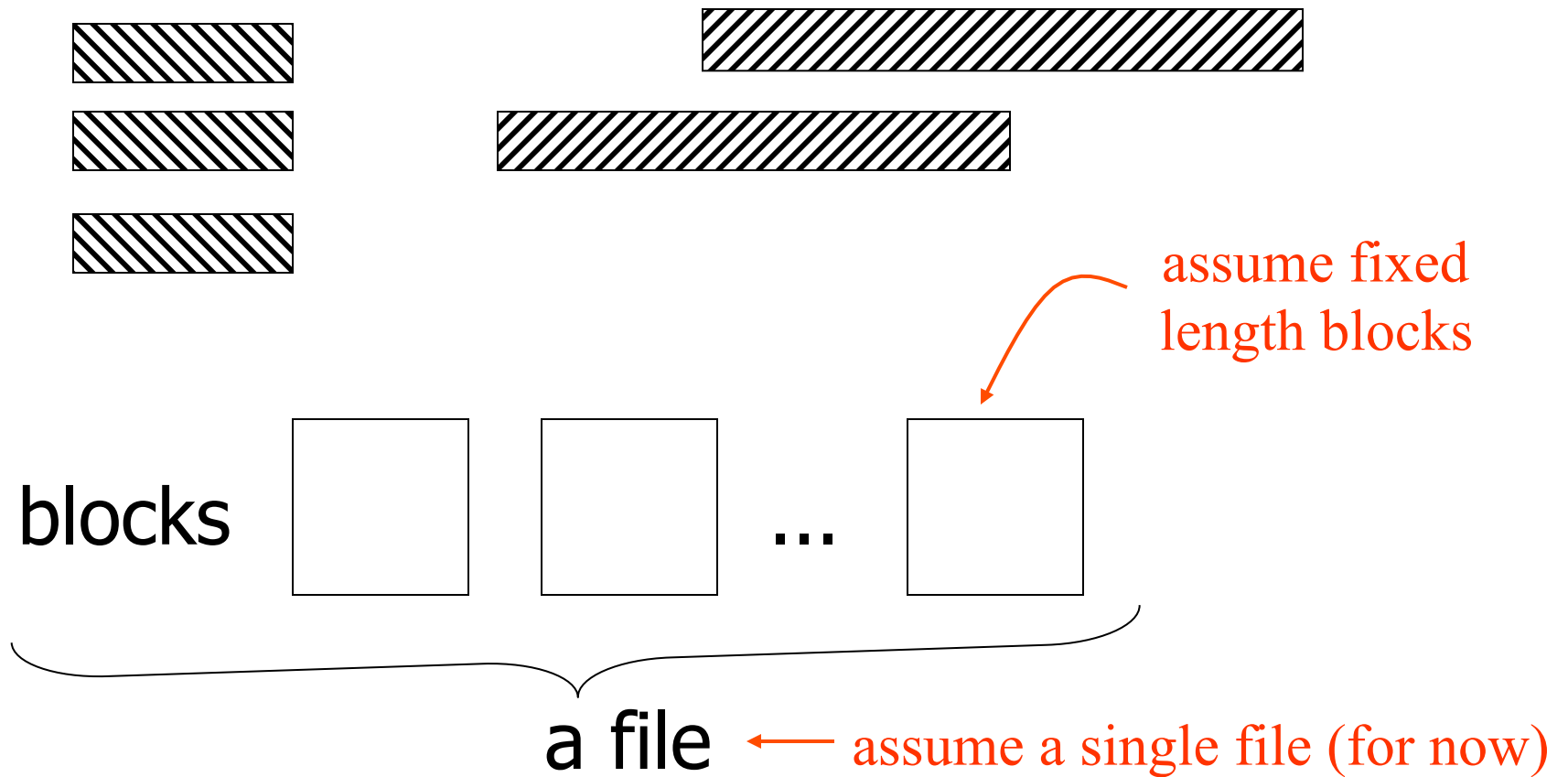

Options for storing records in blocks:

- (1) separating records
- (2) spanned vs. unspanned
- (3) sequencing
- (4) indirection

(1) Separating records

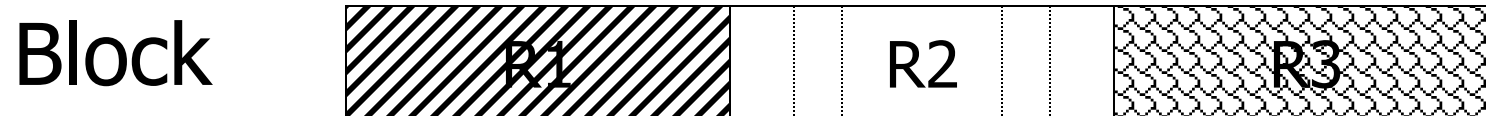

- (a) no need to separate - fixed size recs.
- (b) special marker
- (c) give record lengths (or offsets)
 - within each record
 - in block header

(2) Spanned vs. Unspanned

- Unspanned: records must be within one block

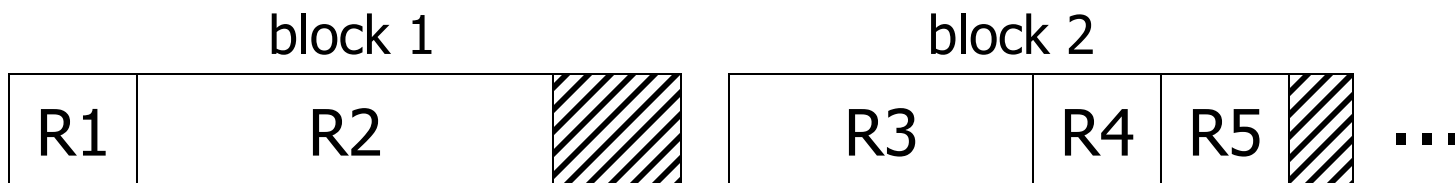

- Spanned

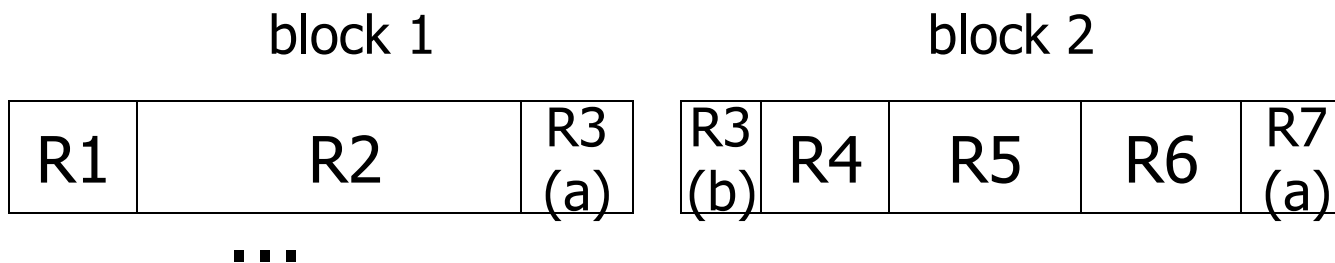

With spanned records:

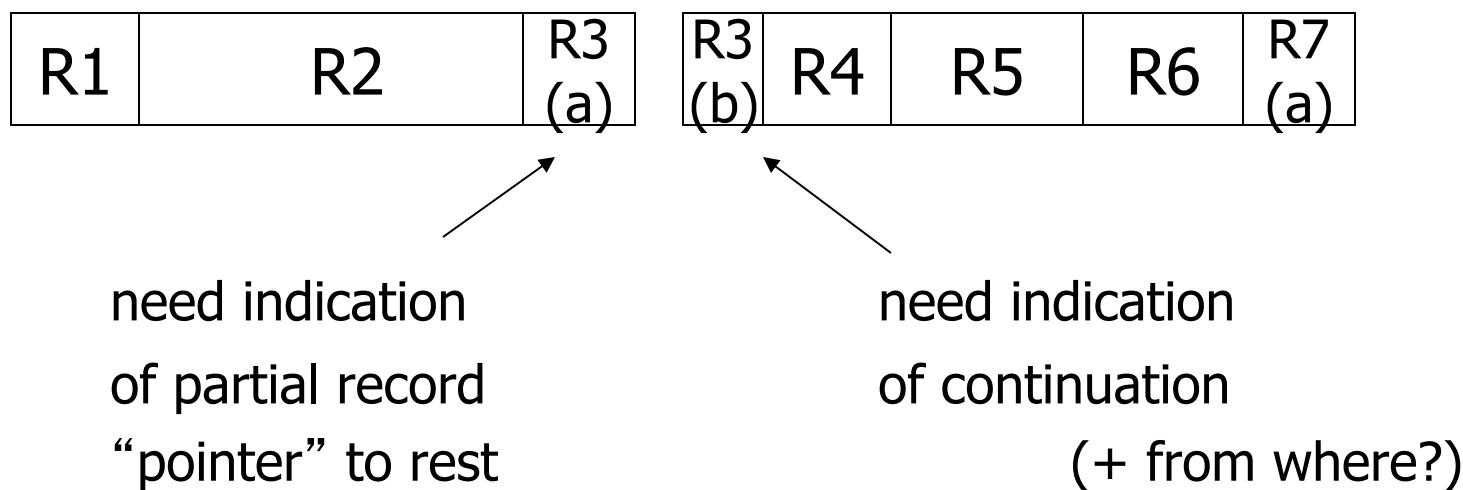

Spanned vs. unspanned:

- Unspanned is much simpler, but may waste space...
- Spanned essential if
record size > block size (!)

Design consideration: record size << block (page) size

(3) Sequencing

- Ordering records in file (and block) by some key value

Sequential file (\Rightarrow sequenced)

Why sequencing?

Typically to make it possible to read efficiently records *in order*.

(e.g., to do a merge-join — discussed later)

Sequencing Options

(a) Next record physically contiguous



(b) Linked

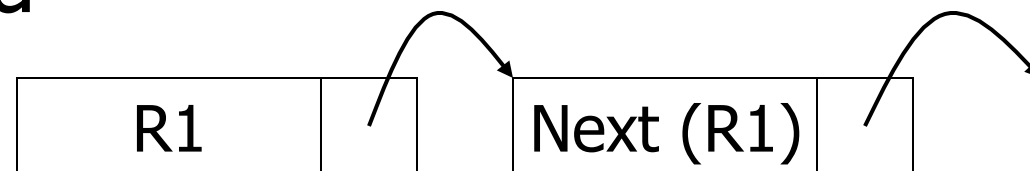

Sequencing Options

(c) Overflow area

Records
in sequence

R1
R2
R3
R4
R5

Sequencing Options

(c) Overflow area

Records
in sequence

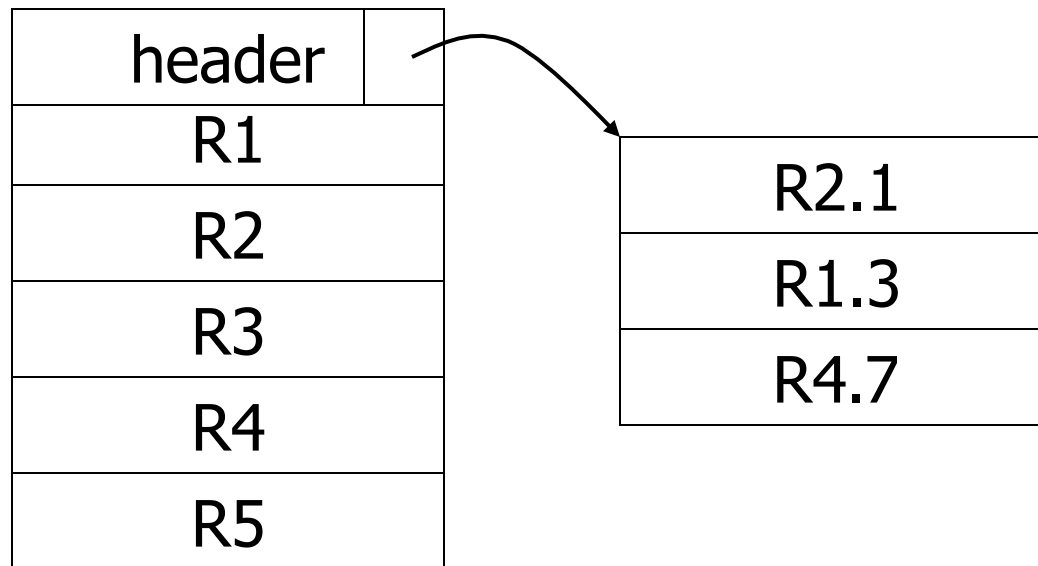

(4) Indirection

- How does one refer to records?

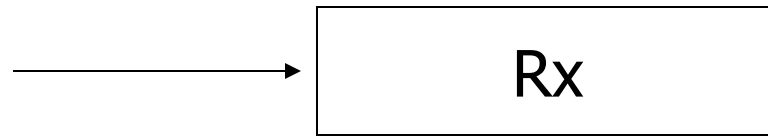

(4) Indirection

- How does one refer to records?



Many options:

Physical



Indirect

☆ Purely Physical

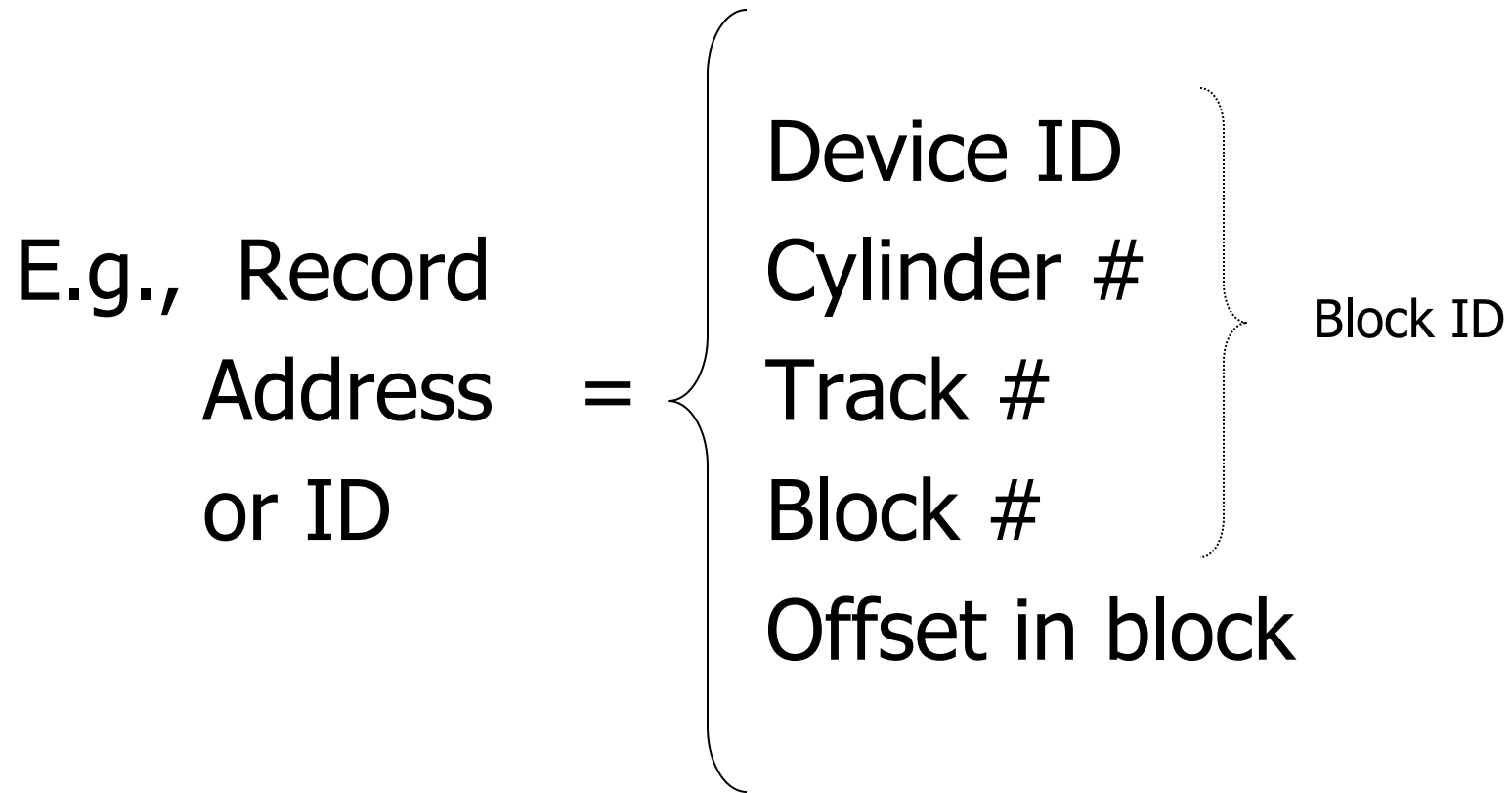

☆ Fully Indirect

E.g., Record ID is arbitrary bit string

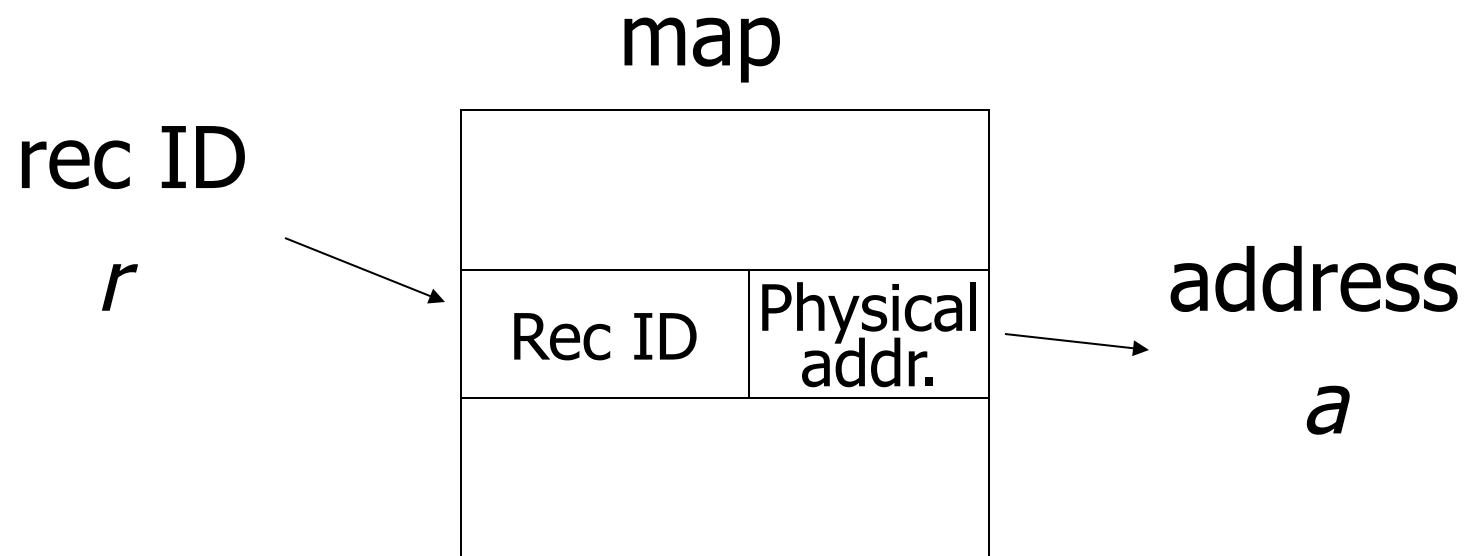

Tradeoff

Flexibility \longleftrightarrow Cost
to move records of indirection
(for deletions, insertions)

Physical \longleftrightarrow Indirect



Many options
in between ...

Example: Indirection in block

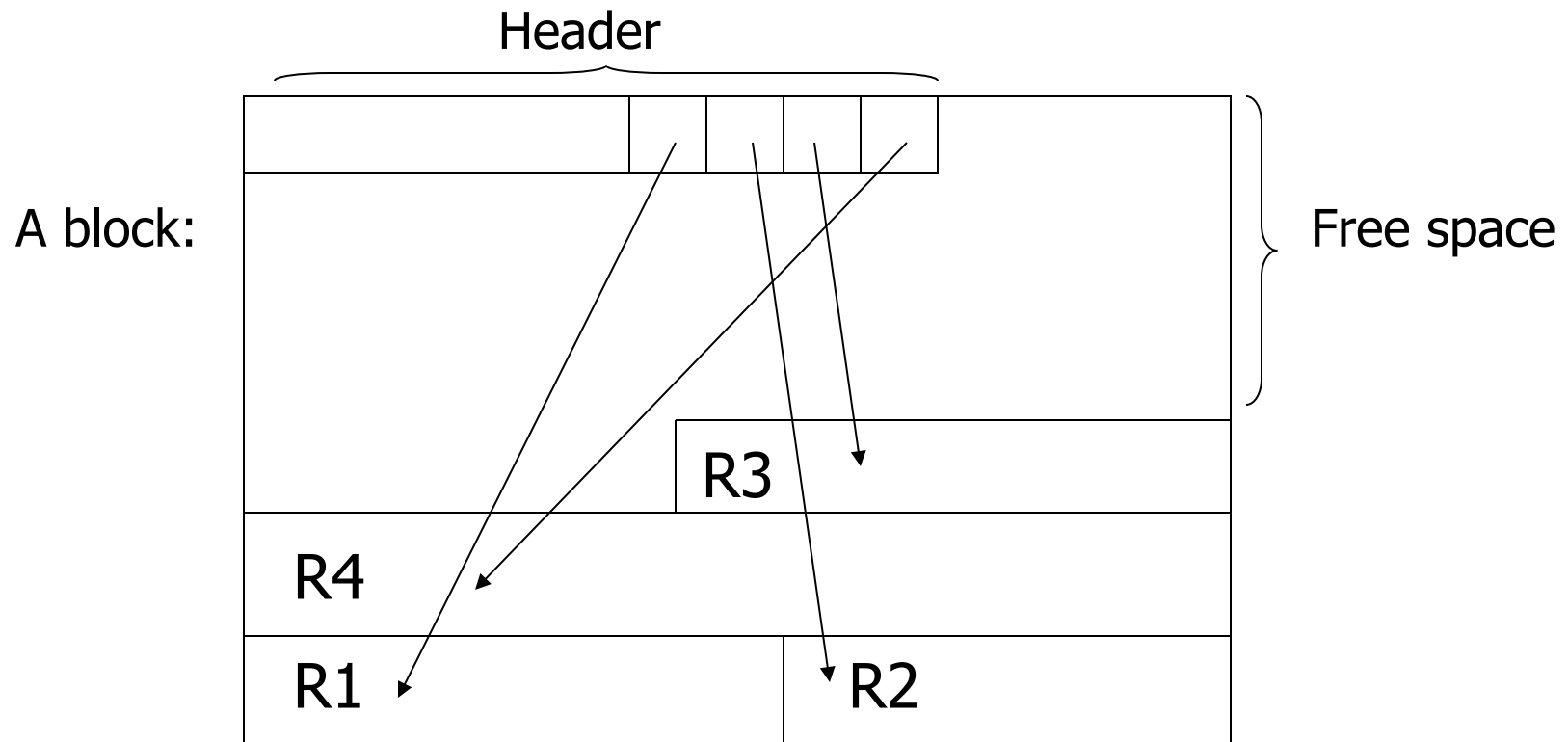

Block header - data at beginning that describes block

May contain:

- File ID (or RELATION or DB ID)
- This block ID
- Record directory
- Pointer to free space
- Type of block (e.g. contains recs type 4;
is overflow, ...)
- Pointer to other blocks “like it”
- Timestamp ...

Options for storing records in blocks:

- (1) separating records
- (2) spanned vs. unspanned
- (3) sequencing
- (4) indirection

Case Study: salesforce.com

- salesforce.com provides CRM services
- salesforce customers are *tenants*
- Tenants run apps and DBMS as service

tenant A

tenant B

tenant C

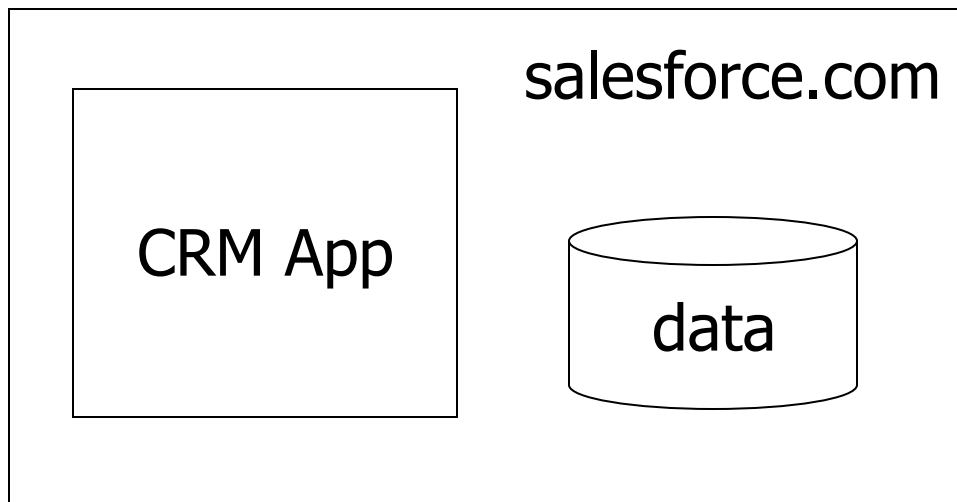

Options for Hosting

- Separate DBMS per tenant
- One DBMS, separate tables per tenant
- One DBMS, shared tables

Tenants have similar data

tenant 1:

customer	A	B	C	D	E	F
	a1	b1	c1	d1	e1	-
	a2	b2	c2	-	e2	f2

tenant 2:

customer	A	B	C	D	G
	a3	b3	c2	-	-
	a1	b1	c1	-	g1
	a4	-	-	d1	

salesforce.com solution

customer	tenant	A	B	C
	1	a1	b1	c1
	1	a2	b2	c2
	2	a3	b3	c2
	2	a1	b1	c1

← fixed schema for all tenants

cust-other	tenant	A	f1	v1	f2	v2 ...
	1	a1	D	d1	E	e1
	1	a2	E	e2	F	f2
	2	a1	G	g1		
	3	a4	D	d1		

← var schema for all tenants

Other Topics

- (1) Insertion/Deletion
- (2) Buffer Management
- (3) Comparison of Schemes

Deletion

Block

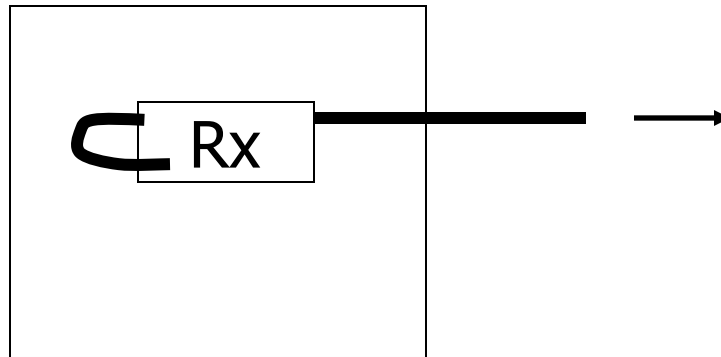

Options:

- (a) Immediately reclaim space
- (b) Mark deleted

Options:

- (a) Immediately reclaim space
- (b) Mark deleted
 - May need chain of deleted records
(for re-use)
 - Need a way to mark:
 - special characters
 - delete field
 - in map

☆ As usual, many tradeoffs...

- How expensive is to move valid record to free space for immediate reclaim?
- How much space is wasted?
 - e.g., deleted records, delete fields, free space chains,...

Concern with deletions

Dangling pointers

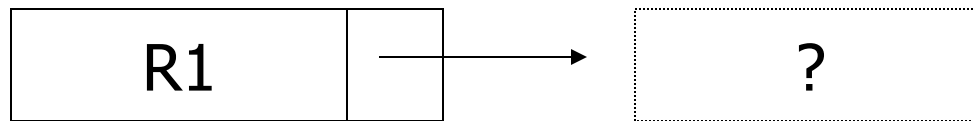

Solution #1: Do not worry

Solution #2: Tombstones

E.g., Leave “MARK” in map or old location

Solution #2: Tombstones

E.g., Leave “MARK” in map or old location

- Physical IDs

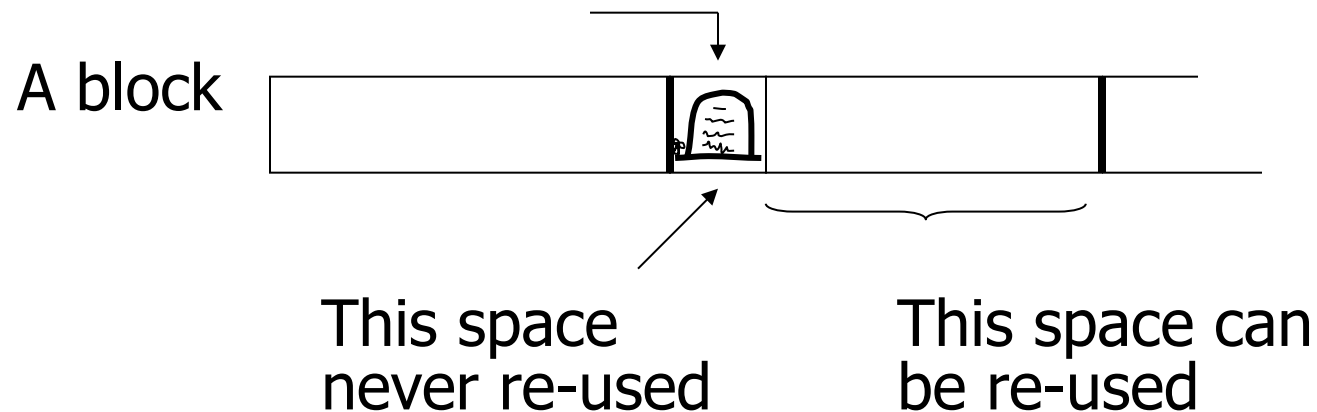

Solution #2: Tombstones

E.g., Leave “MARK” in map or old location

- Logical IDs

map

ID	LOC
7788	



Never reuse
ID 7788 nor
space in map...

Insert

Easy case: records not in sequence

- Insert new record at end of file or in deleted slot
- If records are variable size, not as easy...

Insert

Hard case: records in sequence

- If free space “close by”, not too bad...
- Or use overflow idea...

Interesting problems:

- How much free space to leave in each block, track, cylinder?
- How often do I reorganize file + overflow?

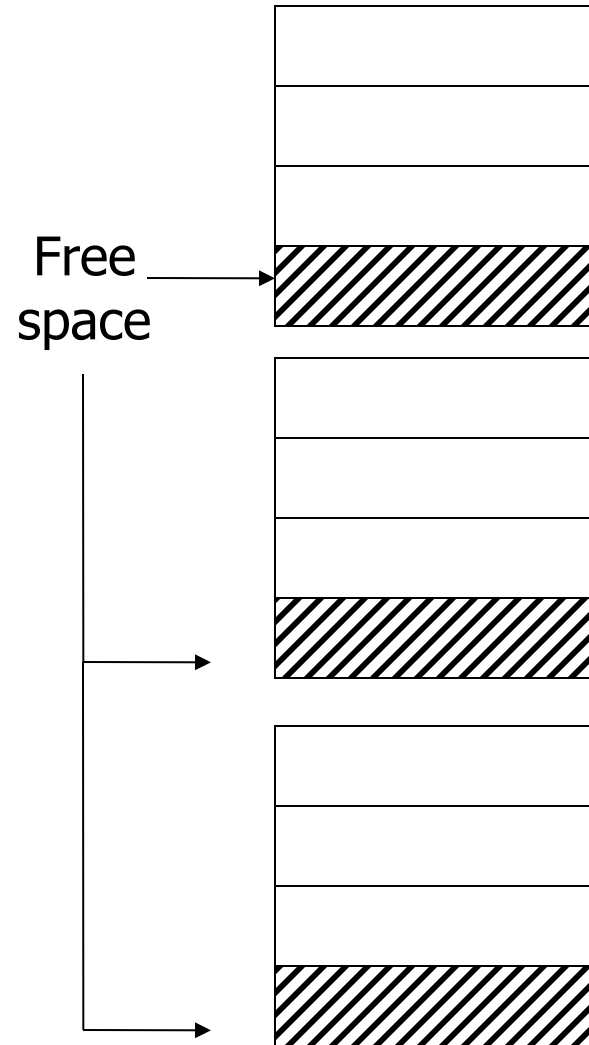

Buffer Management

- DB features needed
- Why LRU may be bad
- Pinned blocks
- Forced output
- Double buffering
- Swizzling

Read
Textbook!

in Notes02

Swizzling

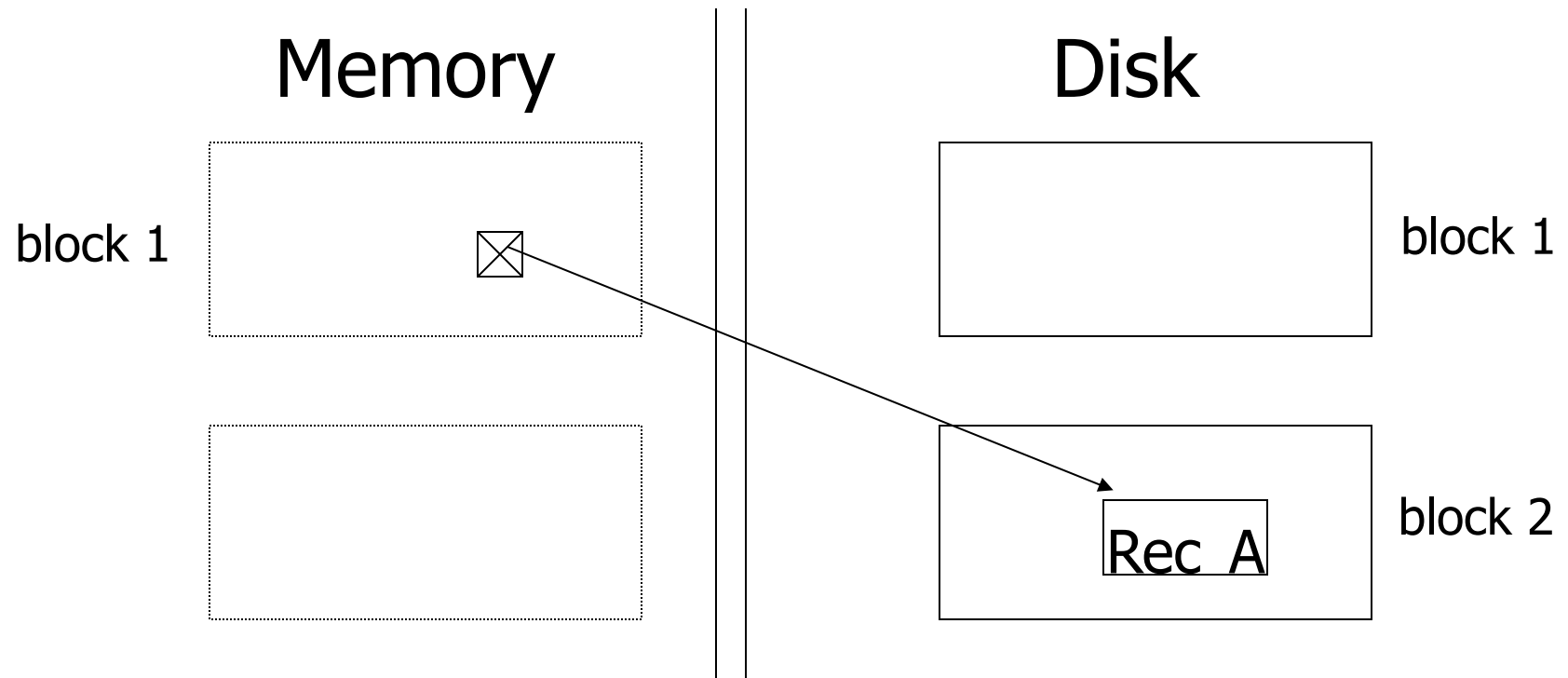

Swizzling

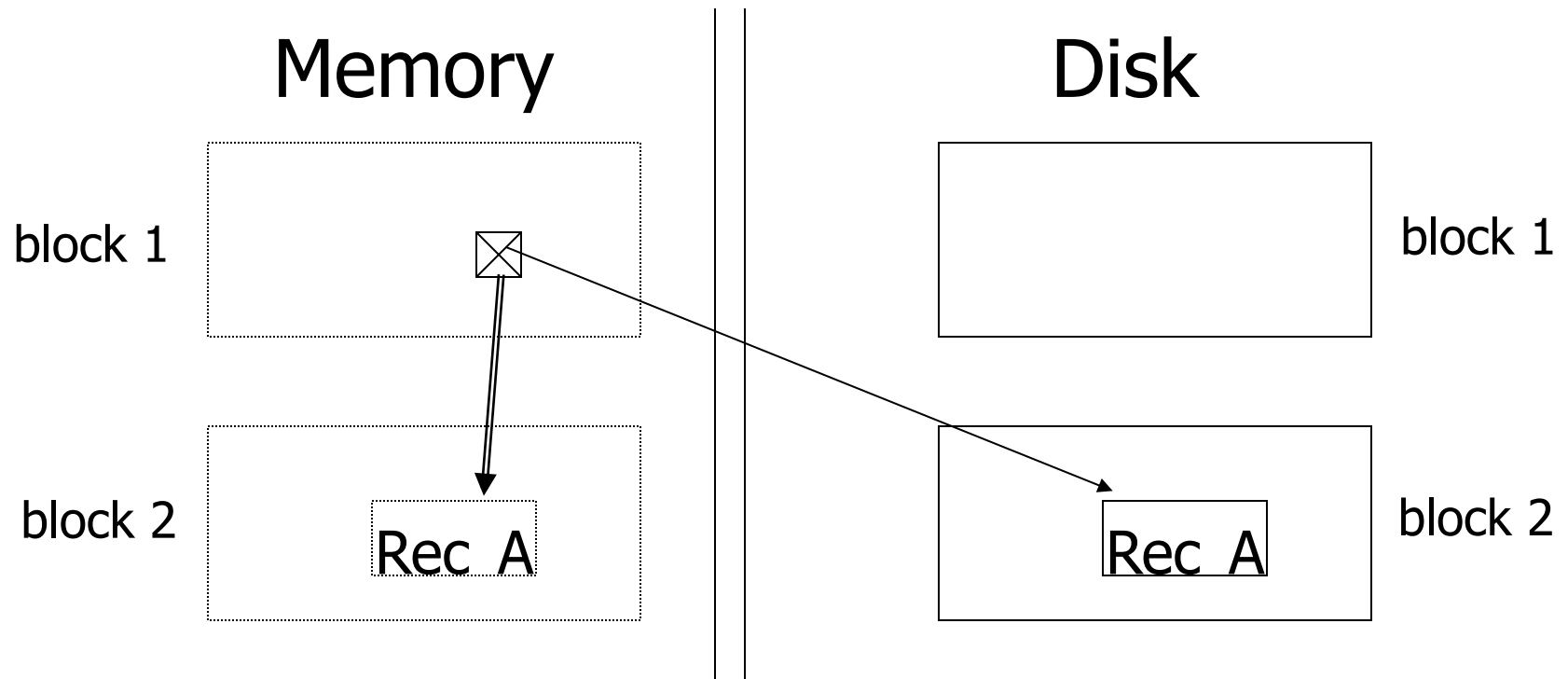

Row vs Column Store

- So far we assumed that fields of a record are stored contiguously (row store)...
- Another option is to store like fields together (column store)

Row Store

- Example: Order consists of
 - id, cust, prod, store, price, date, qty

id1	cust1	prod1	store1	price1	date1	qty1
-----	-------	-------	--------	--------	-------	------

id2	cust2	prod2	store2	price2	date2	qty2
-----	-------	-------	--------	--------	-------	------

id3	cust3	prod3	store3	price3	date3	qty3
-----	-------	-------	--------	--------	-------	------

Column Store

- Example: Order consists of
 - id, cust, prod, store, price, date, qty

id1	cust1
id2	cust2
id3	cust3
id4	cust4
...	...

id1	prod1
id2	prod2
id3	prod3
id4	prod4
...	...

id1	price1	qty1
id2	price2	qty2
id3	price3	qty3
id4	price4	qty4
...

 ids may or may not be stored explicitly

Row vs Column Store

- Advantages of Column Store
 - more compact storage (fields need not start at byte boundaries)
 - efficient reads on data mining operations
- Advantages of Row Store
 - writes (multiple fields of one record) more efficient
 - efficient reads for record access (OLTP)

Interesting paper to read:

- Mike Stonebreaker, Elizabeth (Betty) O'Neil, Pat O'Neil, Xuedong Chen, et al. "C-Store: A Column-oriented DBMS," Presented at the 31st VLDB Conference, September 2005.
- http://www.cs.umb.edu/%7Epponeil/vldb05_cstore.pdf

Comparison

- There are 10,000,000 ways to organize my data on disk...

Which is right for me?

Issues:

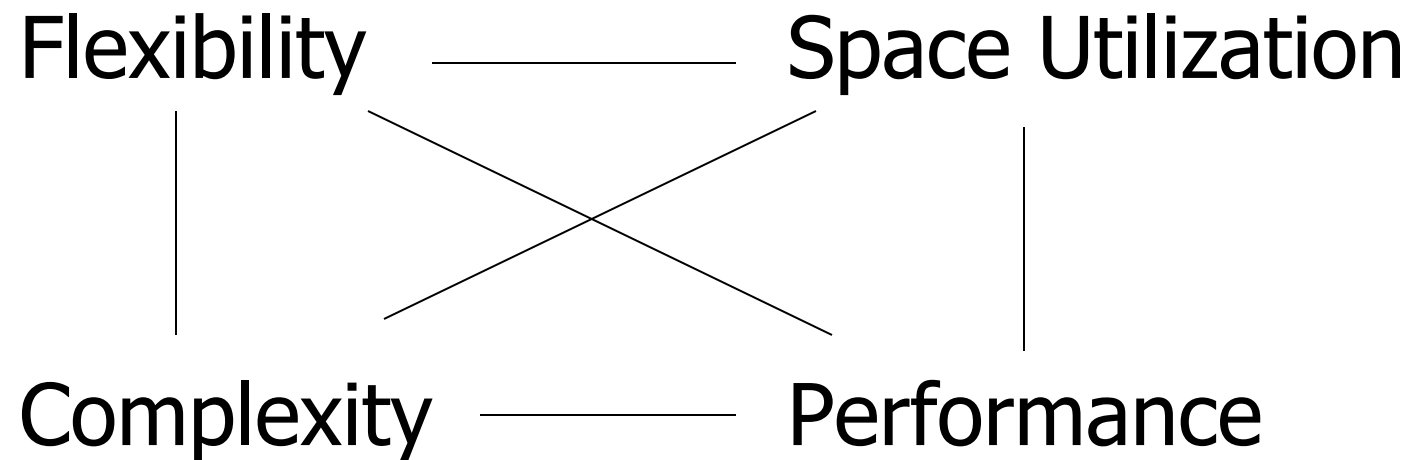

☆ To evaluate a given strategy, compute following parameters:

-> space used for expected data

-> expected time to

- fetch record given key
- fetch record with next key
- insert record
- append record
- delete record
- update record
- read all file
- reorganize file

Example

How would you design Megatron 3000 storage system? (for a relational DB, low end)

- Variable length records?
- Spanned?
- What data types?
- Fixed format?
- Record IDs ?
- Sequencing?
- How to handle deletions?

Summary

- How to lay out data on disk

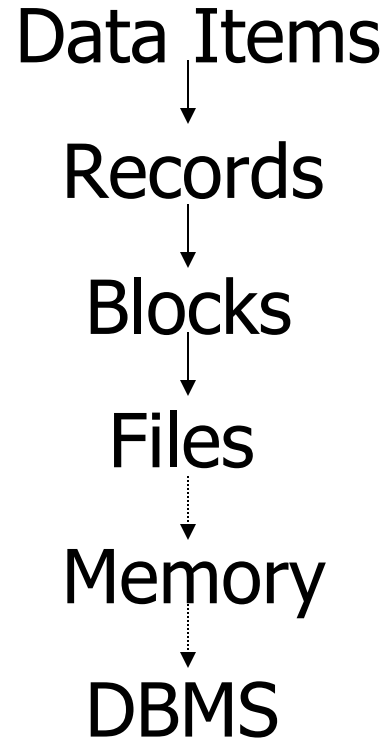



Next

How to find a record quickly,
given a key