

Hash-Based Indexes

Chapter 11

Introduction

- *As for any index, 3 alternatives for data entries \mathbf{k}^* :*
 - Data record with key value \mathbf{k}
 - $\langle \mathbf{k}, \text{rid of data record with search key value } \mathbf{k} \rangle$
 - $\langle \mathbf{k}, \text{list of rids of data records with search key } \mathbf{k} \rangle$
 - Choice orthogonal to the *indexing technique*
- *Hash-based* indexes are best for *equality selections*.
Cannot support range searches.
- Static and dynamic hashing techniques exist;
trade-offs similar to ISAM vs. B+ trees.

Static Hashing

- # primary pages fixed, allocated sequentially, never de-allocated; overflow pages if needed.
- $h(k) \bmod M =$ bucket to which data entry with key k belongs. ($M = \#$ of buckets)

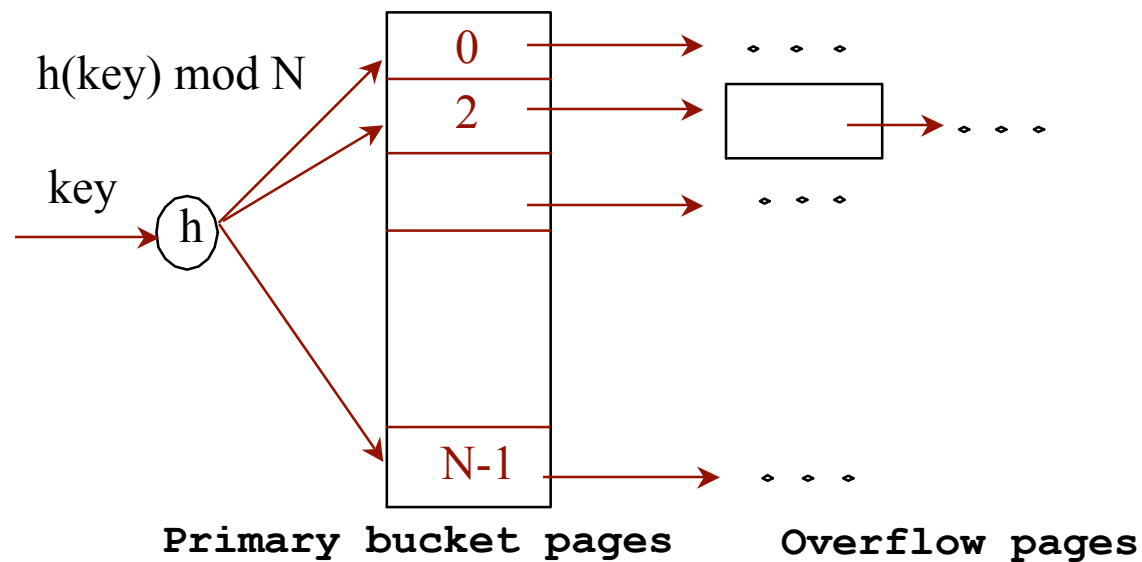

Static Hashing (cont.)

- Buckets contain *data entries*.
- Hash fn works on *search key* field of record r . Must distribute values over range $0 \dots M-1$.
 - $h(key) = (a * key + b)$ usually works well.
 - a and b are constants; lots known about how to tune h .
- **Long overflow chains** can develop and degrade performance.
 - *Extendible* and *Linear Hashing*: Dynamic techniques to fix this problem.

Extendible Hashing

- Situation: Bucket (primary page) becomes full. Why not re-organize file by *doubling* # of buckets?
 - Reading and writing all pages is expensive!
 - Idea: Use directory of pointers to buckets, double # of buckets by *doubling the directory*, splitting just the bucket that overflowed!
 - Directory much smaller than file, so doubling it is much cheaper. Only one page of data entries is split. *No overflow page!*
 - Trick lies in how hash function is adjusted!

Example

- Directory is array of size 4.
- To find bucket for r , take last '*global depth*' # bits of $\mathbf{h}(r)$; we denote r by $\mathbf{h}(r)$.
 - If $\mathbf{h}(r) = 5 = \text{binary } 101$, it is in bucket pointed to by 01.

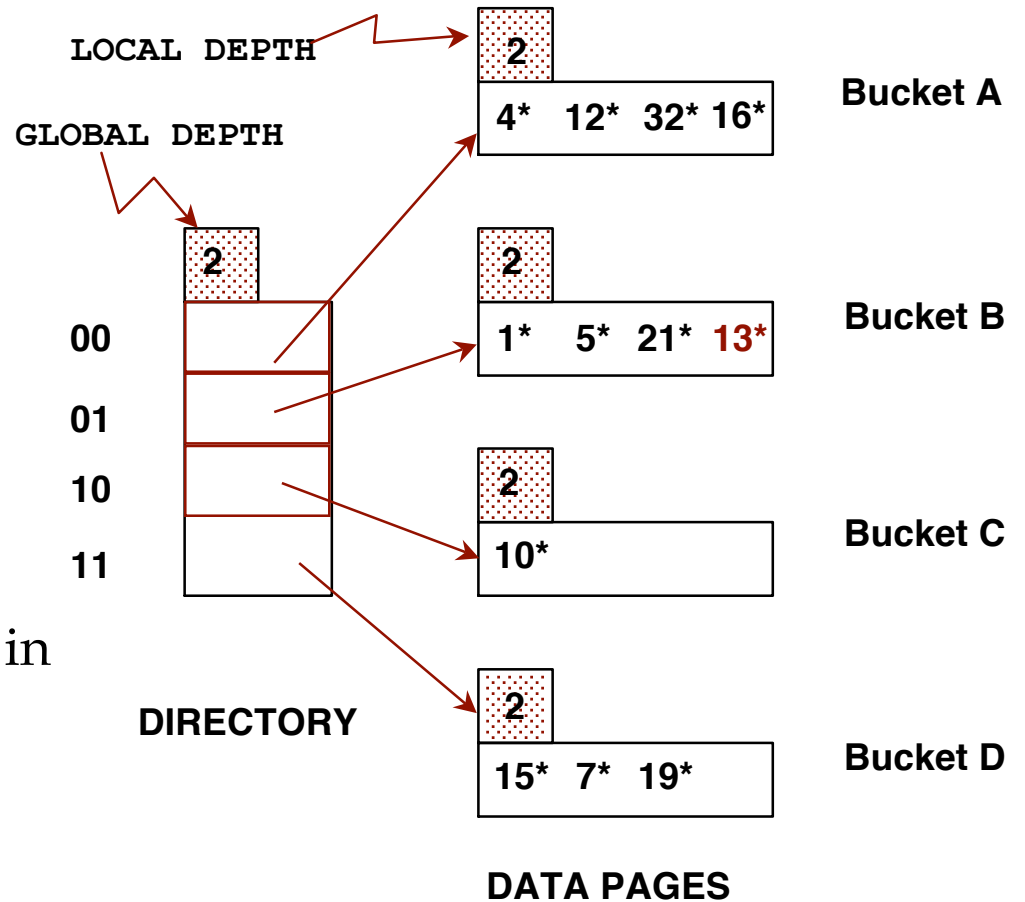

- ❖ **Insert:** If bucket is full, *split* it (allocate new page, re-distribute).
- ❖ *If necessary*, double the directory. (As we will see, splitting a bucket does not always require doubling; we can tell by comparing *global depth* with *local depth* for the split bucket.)

Insert $h(r)=20$ (Causes Doubling)

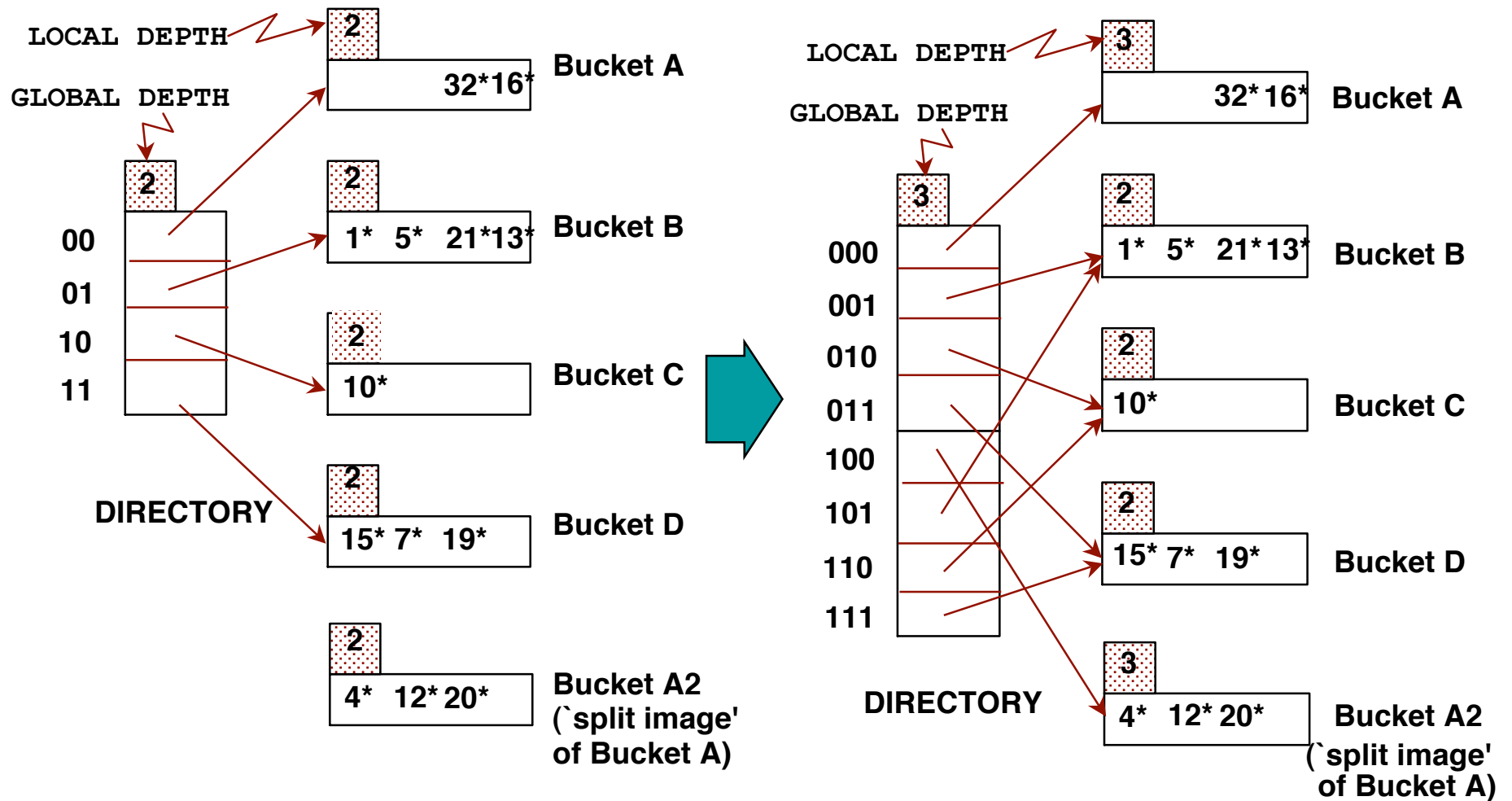

Points to Note

- 20 = binary 10100. Last 2 bits (00) tell us r belongs in A or A2. Last 3 bits needed to tell which.
 - *Global depth of directory*: Max # of bits needed to tell which bucket an entry belongs to.
 - *Local depth of a bucket*: # of bits used to determine if an entry belongs to this bucket.
- When does bucket split cause directory doubling?
 - Before insert, *local depth* of bucket = *global depth*. Insert causes *local depth* to become $>$ *global depth*; directory is doubled by *copying it over* and 'fixing' pointer to split image page. (Use of least significant bits enables efficient doubling via copying of directory!)

Directory Doubling

Why use least significant bits in directory?
 »»→ Allows for doubling via copying!

6 = 110

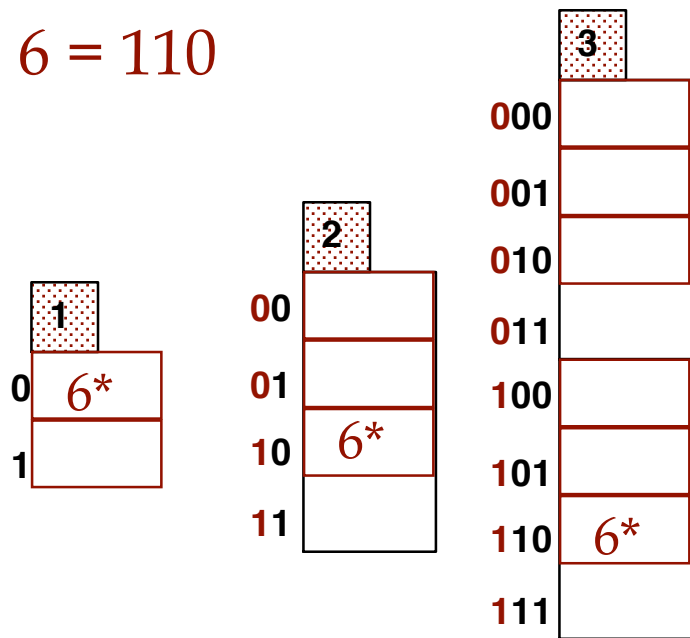

6 = 110

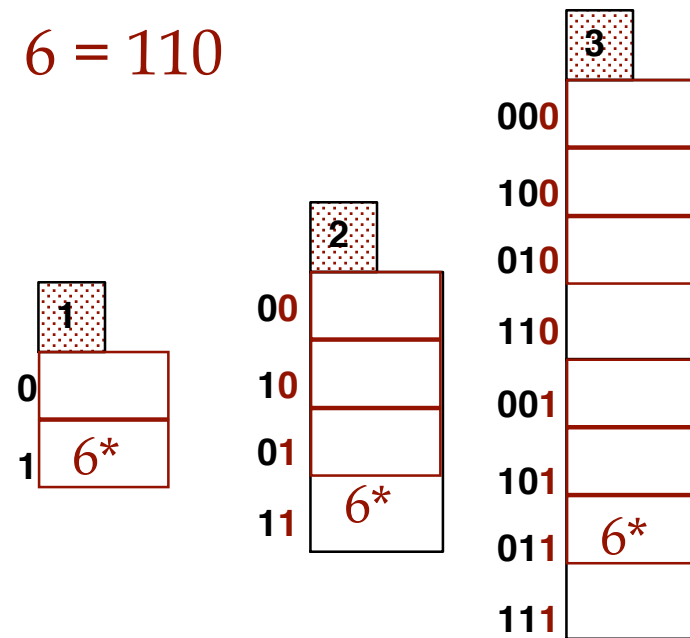

Least Significant

vs.

Most Significant

Comments on Extendible Hashing

- If directory fits in memory, equality search answered with one disk access; else two.
 - 100MB file, 100 bytes/rec, 4K pages contains 1,000,000 records (as data entries) and 25,000 directory elements; chances are high that directory will fit in memory.
 - Directory grows in spurts, and, if the distribution of *hash values* is skewed, directory can grow large.
 - Multiple entries with same hash value cause problems!
- **Delete:** If removal of data entry makes bucket empty, can be merged with 'split image'. If each directory element points to same bucket as its split image, can halve directory.

Linear Hashing

- This is another dynamic hashing scheme, an alternative to Extendible Hashing.
- LH handles the problem of long overflow chains without using a directory, and handles duplicates.
- Idea: Use a family of hash functions $\mathbf{h}_0, \mathbf{h}_1, \mathbf{h}_2, \dots$
 - $\mathbf{h}_i(\text{key}) = \mathbf{h}(\text{key}) \bmod(2^i\mathbf{N})$; \mathbf{N} = initial # buckets
 - \mathbf{h} is some hash function (range is *not* 0 to $\mathbf{N}-1$)
 - If $\mathbf{N} = 2^{d_0}$, for some d_0 , \mathbf{h}_i consists of applying \mathbf{h} and looking at the last d_i bits, where $d_i = d_0 + i$.
 - \mathbf{h}_{i+1} doubles the range of \mathbf{h}_i (similar to directory doubling)

Linear Hashing (cont.)

- Directory avoided in LH by using overflow pages, and choosing bucket to split round-robin.
 - **Splitting proceeds in `rounds`**. Round ends when all N_R initial (for round R) buckets are split. Buckets 0 to $Next-1$ have been split; $Next$ to N_R yet to be split.
 - **Current round number is $Level$** .
 - **Search:** To find bucket for data entry r , find $\mathbf{h}_{Level}(r)$:
 - If $\mathbf{h}_{Level}(r)$ in range ` $Next$ to N_R ', r belongs here.
 - Else, r could belong to bucket $\mathbf{h}_{Level}(r)$ or bucket $\mathbf{h}_{Level}(r) + N_R$; must apply $\mathbf{h}_{Level+1}(r)$ to find out.

Overview of LH File

- In the middle of a round.

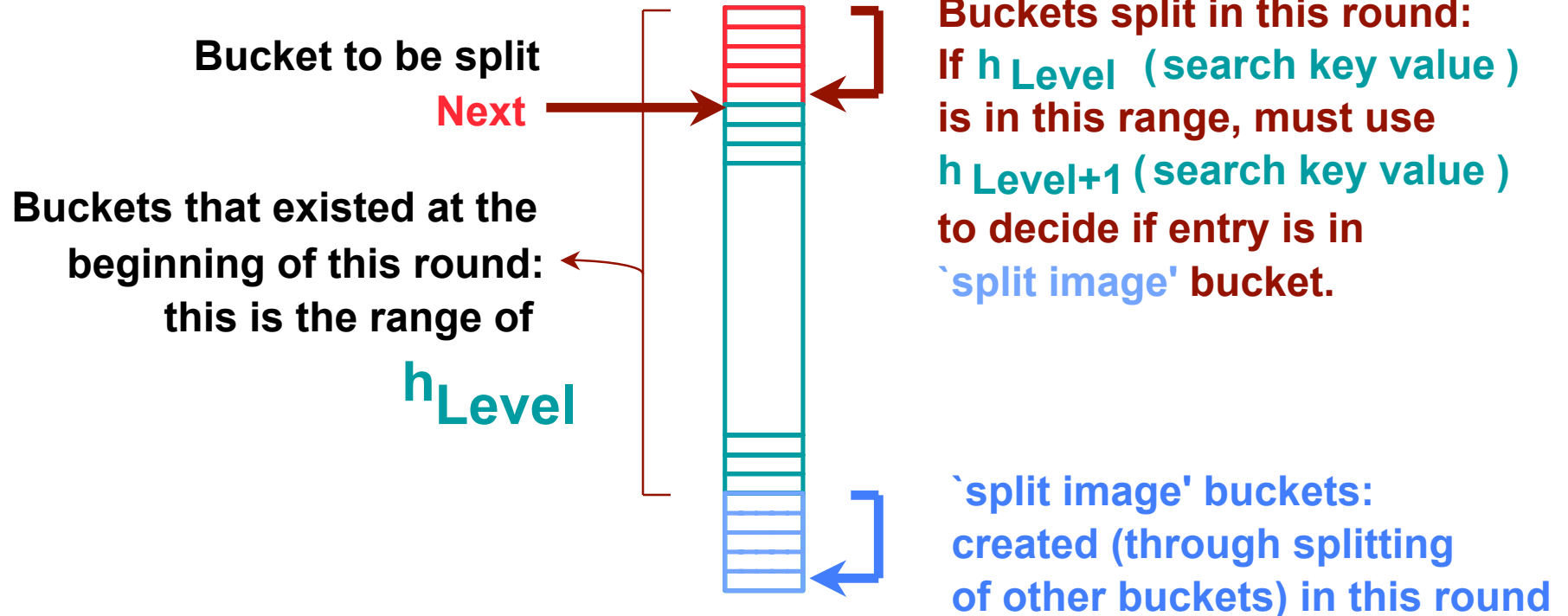

Linear Hashing (cont.)

- **Insert**: Find bucket by applying $h_{Level} / h_{Level+1}$:
 - If bucket to insert into is full:
 - Add overflow page and insert data entry.
 - (*Maybe*) Split *Next* bucket and increment *Next*.
- Can choose any criterion to `trigger' split.
- Since buckets are split round-robin, long overflow chains don't develop!
- Doubling of directory in Extendible Hashing is similar; switching of hash functions is *implicit* in how the # of bits examined is increased.

Example of Linear Hashing

- On split, $h_{\text{Level}+1}$ is used to re-distribute entries.

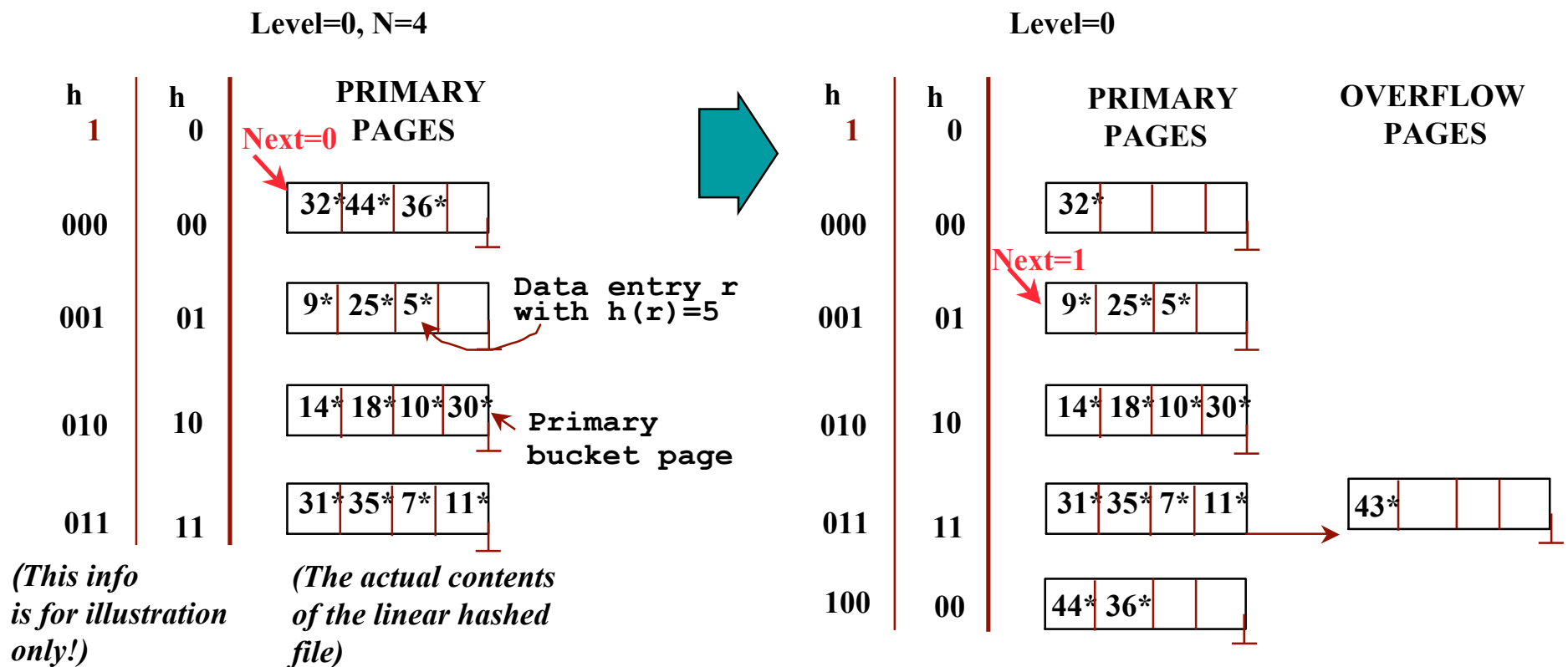

Example: End of a Round

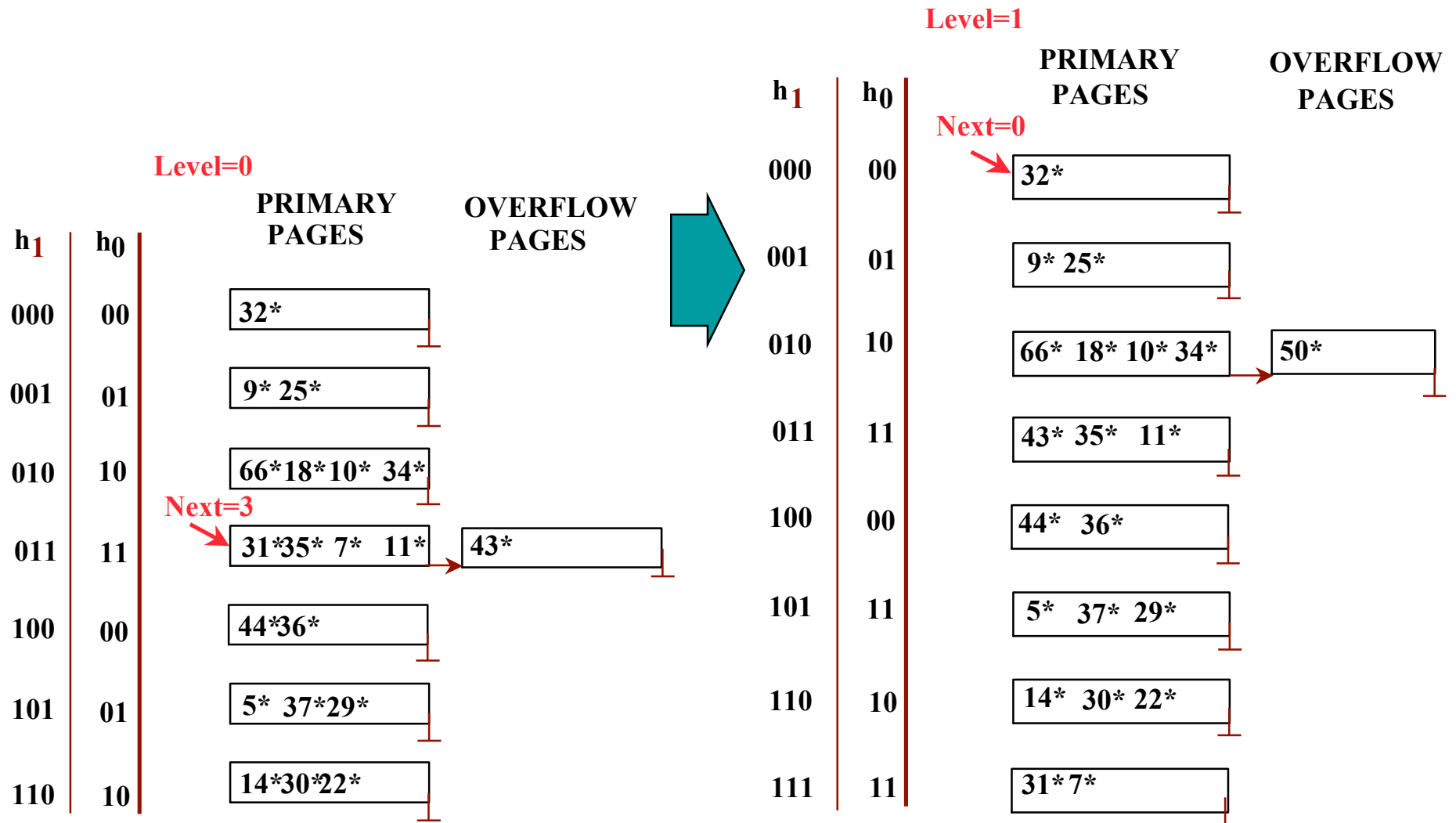

LH Described as a Variant of EH

- The two schemes are actually quite similar:
 - Begin with an EH index where directory has N elements.
 - Use overflow pages, split buckets round-robin.
 - First split is at bucket 0. (Imagine directory being doubled at this point.) But elements $\langle 1, N+1 \rangle$, $\langle 2, N+2 \rangle$, ... are the same. So, need only create directory element N , which differs from 0, now.
 - When bucket 1 splits, create directory element $N+1$, etc.
- So, directory can double gradually. Also, primary bucket pages are created in order. If they are *allocated* in sequence too (so that finding i 'th is easy), we actually don't need a directory! Voila, LH.

Summary

- Hash-based indexes: best for equality searches, cannot support range searches.
- Static Hashing can lead to long overflow chains.
- Extendible Hashing avoids overflow pages by splitting a full bucket when a new data entry is to be added to it. (*Duplicates may require overflow pages.*)
 - Directory to keep track of buckets, doubles periodically.
 - Can get large with skewed data; additional I/O if this does not fit in main memory.

Summary (cont.)

- Linear Hashing avoids directory by splitting buckets round-robin, and using overflow pages.
 - Overflow pages not likely to be long.
 - Duplicates handled easily.
 - Space utilization could be lower than Extendible Hashing, since splits not concentrated on `dense' data areas.
 - Can tune criterion for triggering splits to trade-off slightly longer chains for better space utilization.
- For hash-based indexes, a *skewed* data distribution is one in which the *hash values* of data entries are not uniformly distributed!