DRAGON12-Plus Trainer

For Freescale HCS12 microcontroller family

User's Manual for Rev. F board
Revision 1.06

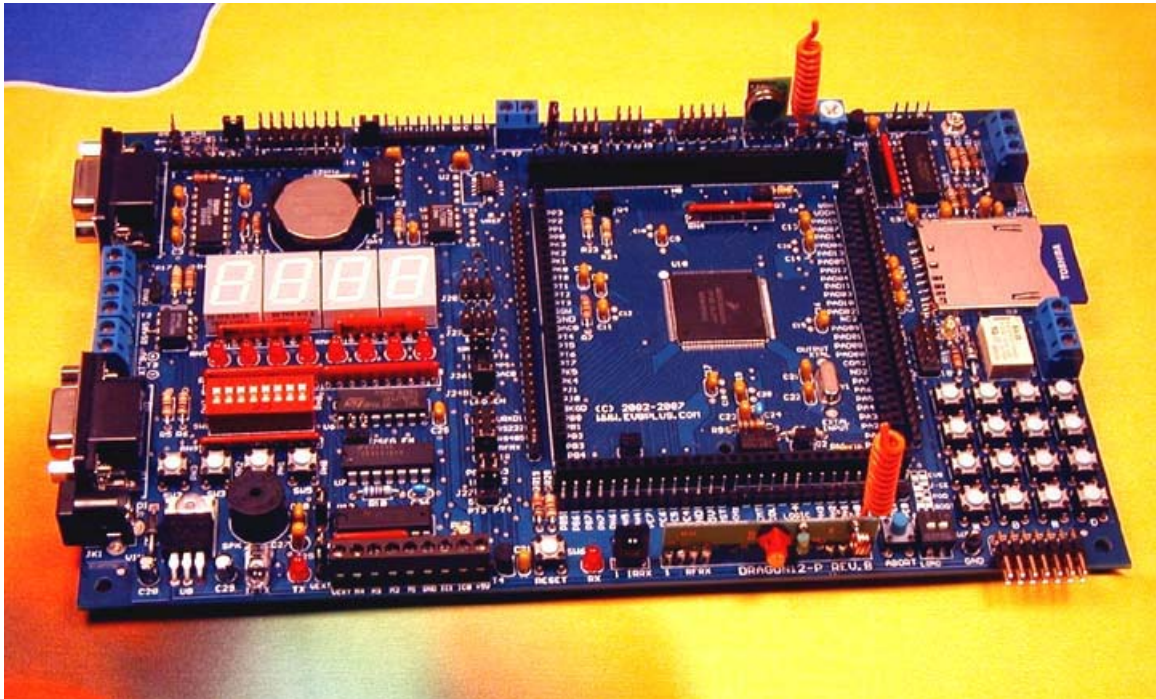

Table OF Contents

Chapter 1. Introduction.....	4
1.1 Welcome.....	4
1.2 MC9S12DG256 features and memory map.....	5
1.3 On-board hardware features	8
1.4 I/O pin usage	9
Chapter 2. Quick Start	12
2.1 Install software from CD	12
2.2 Getting Started	12
2.3 Test hardware	14
Chapter 3. Software Descriptions	15
3.1 Bootloader and D-BUG12 monitor	15
3.1.1 EVB mode	15
3.1.2 Jump to EEPROM mode.....	16
3.1.3 BDM POD mode	16
3.1.4 Bootloader mode	19
3.2 Making a simple assembly program in RAM.....	20
3.3 Software development	22
Chapter 4. Hardware Descriptions	24
4.1 LEDs.....	24
4.2 DIP switch and pushbuttons	24
4.3 7-segment LED multiplexing.....	24
4.4 Keypad.....	26
4.5 LCD.....	27
4.6 Logic Probe.....	27
4.7 Trimmer pot.....	27
4.8 Dual Digital-to-Analog Converter (DACs)	28
4.9 Speaker	28

4.10	IR transceiver and 38 KHz oscillator.....	28
4.11	Dual RS232 communication ports	28
4.12	RS485 communication port.....	29
4.13	External SPI interface.....	29
4.14	External I ² C interface.....	29
4.15	All jumper settings.....	30
Chapter 5.	EmbeddedGNU.....	32
Chapter 6.	Code Warrior and serial monitor.....	34
Chapter 7.	PLL code.....	35
Chapter 8.	Appendix	36
8.1	D-Bug12 utility routines	36
8.2	Interrupt vector tables	37
8.3	Useful web links	40
8.4	Troubleshooting notes.....	40
8.5	Revision Histroy.....	42

1.1 Welcome

Thank you very much for purchasing our Dragon12-Plus trainer. The Dragon12-Plus trainer is a low-cost, feature-packed training board for the new Freescale HCS12 microcontroller family. It is compatible with the Freescale 9S12DP256EVB board and other similar development boards on the market today, but it also incorporates many on-board peripherals that make this board a popular trainer in universities around the world.

For engineers, it is a convenient prototype system suitable for designers who want to rapidly develop and prototype new HCS12 applications. For students, it can not only be used as a general trainer for freshman and sophomore students, but also as a versatile platform for senior projects as well. The new features of the Dragon12-Plus board create a new potential for students at every level.

The Dragon12-Plus trainer kit comes with the following items:

1. Dragon12-Plus board
2. CD Software downloadable from our web site:
 - a. AsmIDE with HCS12 assembler
 - b. Sample programs with source code
 - c. Freescale application notes for the HCS12
 - d. Data sheets for on-board hardware
 - e. User's manual
 - f. Reference documents
3. 6 foot DB9 cable
4. 9V, 500mA-1000mA AC adapter for North America customers only. We do not offer an AC adapter to customers in other countries because the additional shipping cost of an AC adapter will be higher than if you buy one at a local store.

If you miss any part of the kit, please contact sales@EVbplus.com or call 630 894-1440 for help.

Sometime the kit includes two 6-pin IDC connectors at no charge if we have them in stock. You may use them to make a BDM cable in the future.

Please carefully examine the default jumper settings before turning on the board:

1. The J1 should have a jumper for LCD backlight.
2. The J24 should have a jumper installed, but J18 should not have a jumper if there is no motor connected to the terminal block T4. The jumper on J18 will turn on the H-Bridge U12. If you see a jumper on J18, move it to J24 to reduce power consumption.
3. The J26 should have a jumper in the "top" position, so the speaker will be driven by PT5. The speaker can be driven by timer (PT5) or PWM (PP5) or DAC. It defaults for PT5. Without a jumper installed on J26 the speaker won't sound.

The specification of the AC adapter is:

- DC input: 110V
- DC output: 9V
- Current rating: 500mA-1000mA
- Type of plug: 2.1mm female barrier plug, center positive

WARNING: If more power is needed in a robot or other applications, the user should upgrade the AC adapter. Otherwise, the board would keep resetting itself when the VCC drops below 4.6V.

Do not apply a DC voltage higher than 9V to this board.

1.2 MC9S12DG256 features and memory map:

The Dragon12-Plus board comes with the MC9S12DP256CCPV or the MC9S12DG256CVPE installed. The MC9S12DG256 is the best replacement for the MC9S12DP256 since the latter has been discontinued by Freescale. The only difference between DG256 and DP256 is the number of CAN ports. The DG256 has 2 CAN ports, but the DP256 has 5 CAN ports. Other than the different number of CAN port these two microcontrollers have the same features. If you don't use more than 2 CAN ports these two chips are identical and **all datasheets and manuals** for the DP256 can be used for the DG256.

If your application that needs more than two CAN ports please contact us at sales@evbplus.com and we may be able to ship the board installed with the DP256.

The MC9S12DG256 microcontroller consists of a powerful 16-bit CPU (central processing unit), 256K bytes of flash memory, 12K bytes of RAM, 4K bytes of EEPROM and many on-chip peripherals.

The main features of the MC9S12DG256 are listed below:

- Powerful 16-bit CPU
- 256K bytes of flash memory
- 12K bytes of RAM
- 4K bytes of EEPROM
- SCI ports
- SPI ports
- CAN 2.0 ports
- I²C interface
- 8-ch 16-bit timers
- 8-ch 8-bit or 4-ch 16 bit PWM
- 16-channel 10-bit A/D converter
- Fast 25 MHz bus speed via on-chip Phase Lock Loop
- BDM for in-circuit programming and debugging
- 112-pin LQFP package offers up to 91 I/O in a small footprint

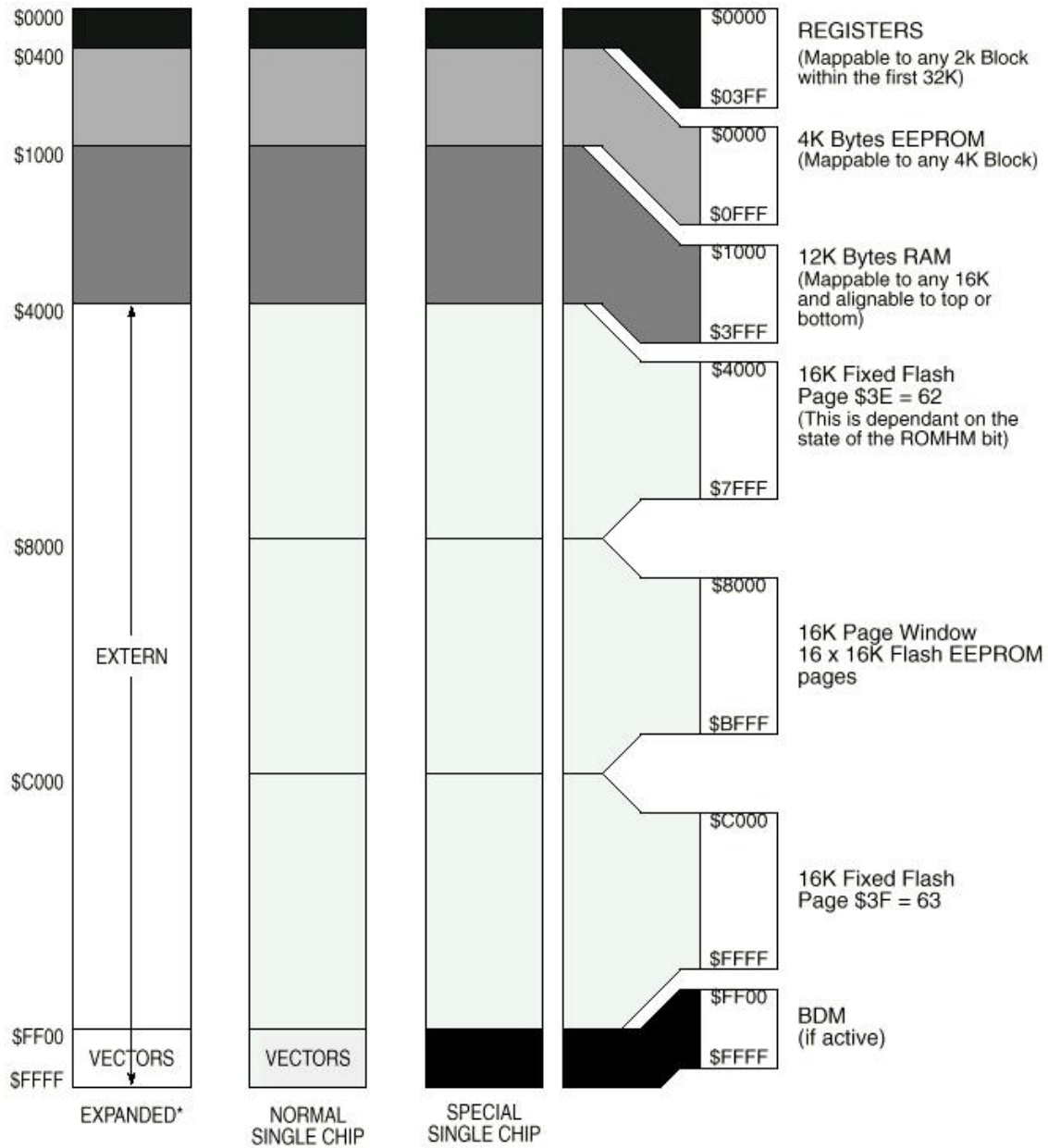

* Assuming that a '0' was driven onto port K bit 7 during MCU is reset into normal expanded wide or narrow mode.

Fig 1-1: MC9S12DG256 Memory map

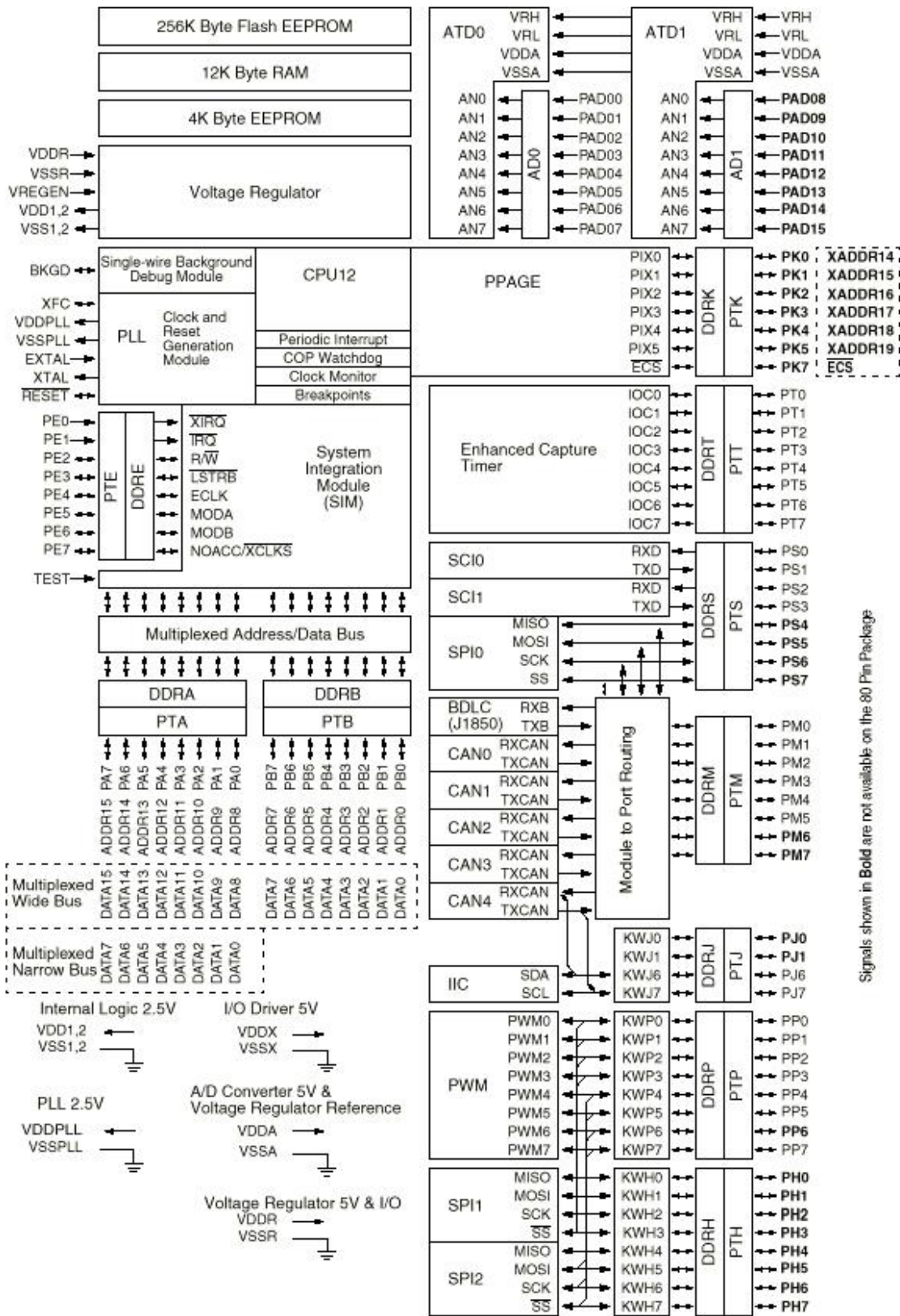
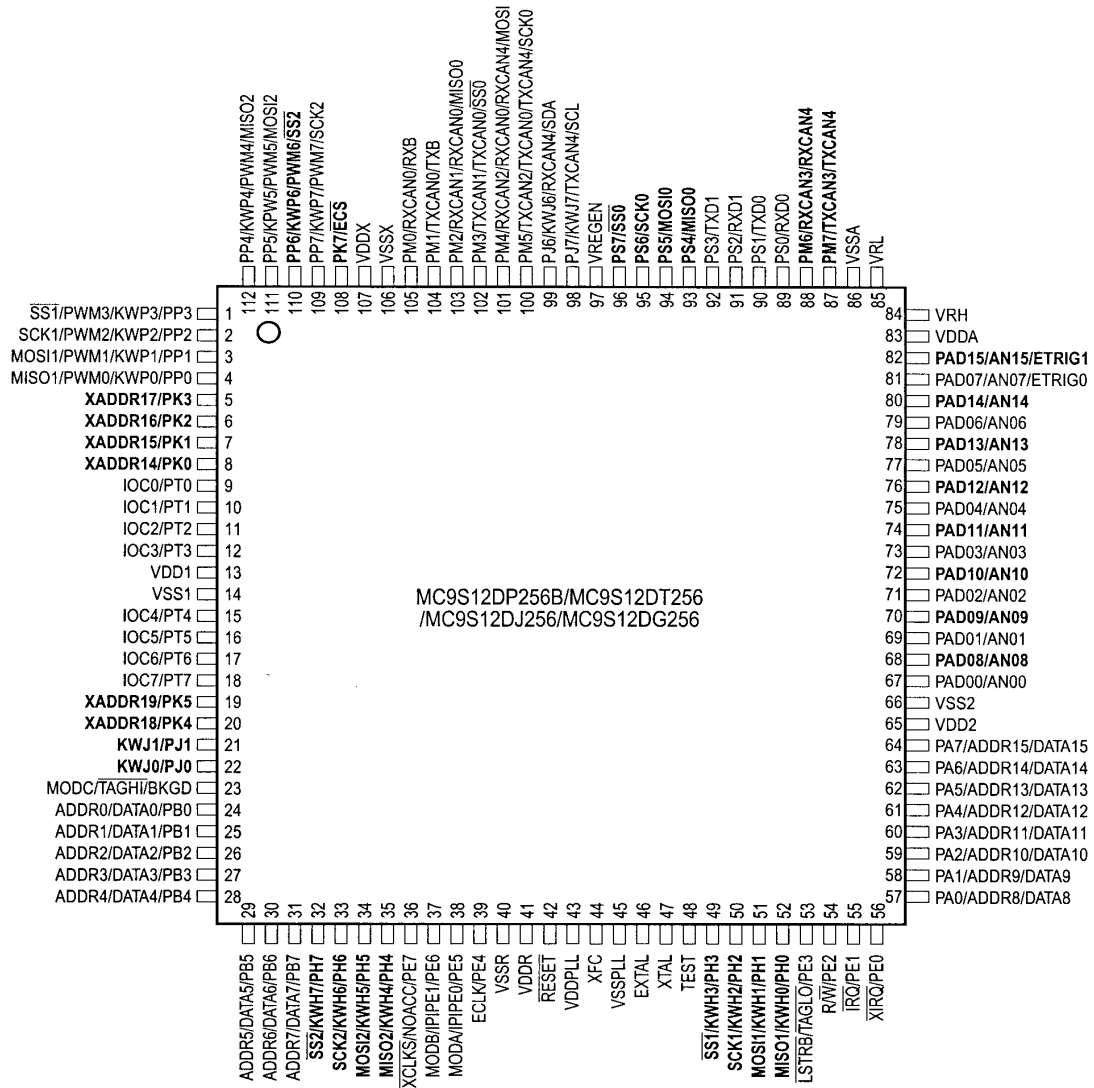

Fig 1-2: MC9S12DG256 MCU block diagram



Signals shown in **Bold** are not available on the 80 Pin Package

Fig 1-3: MC9S12DG256 MCU pin assignments

1.3 On-board hardware features:

The Dragon12-Plus board includes the following features:

1. Dual RS232 communication ports
2. RS485 communication port
3. DS1307 RTC with backup battery included for testing I²C interface
4. I²C expansion port for interfacing external I²C devices
5. CAN port
6. SPI expansion port for interfacing external SPI devices
7. Dual 10-bit DAC for testing SPI interface and generating analog waveforms
8. Four robot servo controllers with terminal block for external 5V
9. Four digit 7-segment LED display for learning multiplexing technique
10. Eight LEDs

11. Eight-position DIP switch
12. Four push button switches
13. 5V regulator with DC jack and terminal block for external 9V battery input
14. Speaker to be driven by timer, or DAC or PWM signal for alarm or music applications.
15. Dual H-Bridge motor driver with motor feedback or rotary encoder interface for controlling two DC motors or one Stepper motor
16. Power-On LED indicator
17. IR transceiver with on-board 38KHz oscillator
18. BDM-in connector to be connected with a BDM from multiple vendors for debugging
19. BDM POD mode for programming other HCS12 boards. No extra hardware needed
20. Opto-coupler output
21. Logic probe with LED indicator
22. Abort switch for stopping program when program is hung in a dead loop
23. Mode switch for selecting 4 operating modes: EVB, Jump-to-EEPROM, BDM POD and Bootloader
24. 4 X 4 keypad
25. Form C relay output rated at 3A/30V or 1A/125V
26. Relay-On LED indicator
27. X-Y-Z accelerometer interface or GP2-D12 distance measuring sensor interface for distance measurement
28. Potentiometer trimmer pot for analog input
29. Temperature sensor
30. Communication port for VGA camera with built-in JPEG compression. (Camera is optional)
31. Light sensor
32. Female and male headers provide shortest distance (great for high speed applications!) from bread board to every I/O pin of the MC9S12DG256
33. PC board size is 8.4" X 5.35"

The Dragon12-Plus board has the following features as options:

34. RF transmitter
35. RF receiver
36. SD memory interface
37. VGA camera with JPEG compression

The Dragon12-Plus board includes the following features, but not shown in the picture on the front page of this manual:

1. A 16X2 LCD display module with LED backlight is included for learning LCD interface software, but not shown in the picture on the front page. It can be replaced by any size of LCD display module via a 16-pin (8X2) cable assembly.
2. A solderless breadboard is included for fast prototyping, but not shown in the picture on the front page.

1.4 I/O Pin Usage

Many I/O pins of the MC9S12DG256 on the Dragon12-Plus board are used by on-board peripherals and it seems that there are only a few of unused pins left for your circuits on the breadboard. Fortunately, it's unlikely that all on-board peripherals will be used by one application program. So the I/O pins on unused peripheral devices can still be used by your circuits on the breadboard. For instance, if you don't touch the 4x4 on-board keypad, the entire port A will be available to your circuits. If you don't use the LCD or just unplug the LCD, the port K will be available as well. Port B drives LEDs, but if you ignore the status of the LED, the port B can drive any other I/O devices on the breadboard. Each pin in port H reads a switch, but it still can be used as an input for reading a TTL or CMOS output from your circuits.

Pin Name	Pin #	I/O Usage
PA0 (output)	Pin 57	Col_0 of keypad
PA1 (output)	Pin 58	Col_1 of keypad
PA2 (output)	Pin 59	Col_2 of keypad
PA3 (output)	Pin 60	Col_3 of keypad
PA4 (input)	Pin 61	Row_0 of keypad
PA5 (input)	Pin 62	Row_1 of keypad
PA6 (input)	Pin 63	Row_2 of keypad
PA7 (input)	Pin 64	Row_3 of keypad
PB0 (output)	Pin 24	LED0 or H-bridge
PB1 (output)	Pin 25	LED1 or H-bridge
PB2 (output)	Pin 26	LED2 or H-bridge
PB3 (output)	Pin 27	LED3 or H-bridge
PB4 (output)	Pin 28	LED4
PB5 (output)	Pin 29	LED5
PB6 (output)	Pin 30	LED6
PB7 (output)	Pin 31	LED7
PE0 (input)	Pin 56	Abort switch SW8
PE1	Pin 55	not used
PE2 (output)	Pin 54	Relay
PE3 (output)	Pin 53	Opto-coupler
PE4	Pin 39	not used
PE5	Pin 38	not used
PE6	Pin 37	not used
PE7	Pin 36	not used
PH0 (input)	Pin 52	DIP switch 1 or pushbutton switch SW5
PH1 (input)	Pin 51	DIP switch 2 or pushbutton switch SW4 (input)
PH2 (input)	Pin 50	DIP switch 3 or pushbutton switch SW3 (input)
PH3 (input)	Pin 49	DIP switch 4 or pushbutton switch SW2 (input)
PH4 (input)	Pin 35	DIP switch 5 (input)
PH5 (input)	Pin 34	DIP switch 6 (input)
PH6 (input)	Pin 33	DIP switch 7 (input)
PH7 (input)	Pin 32	DIP switch 8 (input)
PJ0 (output)	Pin 22	DIR of RS485
PJ1 (output)	Pin 21	LED enable
PJ6	Pin 99	SDA for DS1307(U11) or external I2C (J2)
PJ7	Pin 98	SCL for DS1307(U11) or external I2C (J2)
PK0 (output)	Pin 8	RS of LCD module
PK1 (output)	Pin 7	EN of LCD module
PK2	Pin 6	DB4 of LCD module (bi-directional)
PK3	Pin 5	DB5 of LCD module (bi-directional)
PK4	Pin 20	DB6 of LCD module (bi-directional)
PK5	Pin 19	DB7 of LCD module (bi-directional)
PK7 (output)	Pin 108	R/W of LCD module

Table 1-1: I/O pin usage list 1

Pin Name	Pin #	I/O Usage
PM0	Pin 105	CAN0
PM1	Pin 104	CAN0
PM2	Pin 103	Write Enable for SD memory
PM3	Pin 102	Card detect for SD memory
PM4	Pin 101	CS of SD memory
PM5	Pin 100	not used
PM6	Pin 88	CS of LTC1661 (DAC)
PM7	Pin 87	I/O for external SPI (J10)
PP0 (output)	Pin 4	Digit 3 of 7-segment display or EN12 of H-bridge
PP1 (output)	Pin 3	Digit 2 of 7-segment display or EN34 of H-bridge
PP2 (output)	Pin 2	Digit 1 of 7-segment display
PP3 (output)	Pin 1	Digit 0 of 7-segment display
PP4 (output)	Pin 112	Servo motor 1
PP5 (output)	Pin 111	Servo motor 2
PP6 (output)	Pin 110	Servo motor 3
PP7 (output)	Pin 109	Servo motor 4
PS0	Pin 89	SCI0 for PC communication, RECV (DB9 connector P1)
PS1	Pin 90	SCI0 for PC communication, XMIT (DB9 connector P1)
PS2	Pin 91	SCI1 for user applications, RECV, selected by J23
PS3	Pin 92	SCI1 for user applications, XMIT
PS4	Pin 93	MISO for LTC1661, SD memory interface and external SPI (J10)
PS5	Pin 94	MOSI for LTC1661, SD memory interface and external SPI (J10)
PS6	Pin 95	SCLK for LTC1661, SD memory interface and external SPI (J10)
PS7	Pin 96	I/O for external SPI (J10)
PT0 (input)	Pin 9	Rotary encoder
PT1 (input)	Pin 10	Rotary encoder
PT2	Pin 11	not used
PT3 (input)	Pin 12	IR RECV when jumpers on J27 set for PT3 and PT4
PT4 (output)	Pin 15	IR XMIT when jumpers on J27 are set for PT3 and PT4
PT5 (output)	Pin 16	Speaker (output)
PT6 (output)	Pin 17	BDMout reset (used in POD mode only)
PT7	Pin 18	BDMout data line (bi-directional, used in POD mode only)
PAD0	Pin 67	D-bug12 mode select, SW7
PAD1	Pin 69	D-bug12 mode select, SW7
PAD2	Pin 71	Alarm trigger1, analog or digital input
PAD3	Pin 73	Alarm trigger2, analog or digital input
PAD4	Pin 75	Light sensor (phototransistor Q1)
PAD5	Pin 77	Temperature sensor (U14, MCP9701A)
PAD6	Pin 79	Not Used
PAD7	Pin 81	Trimmer pot VR2
PAD8	Pin 68	X axis input for Wytec accelerometer or ADC input for GP12D2
PAD9	Pin 70	Y axis input for Wytec accelerometer or ADC input for GP12D2
PAD10	Pin 72	Z axis input for Wytec accelerometer or ADC input for GP12D2
PAD11	Pin 74	not used
PAD12	Pin 76	not used
PAD13	Pin 78	not used
PAD14	Pin 80	not used
PAD15	Pin 82	not used

Table 1-2: I/O pin usage list 2

By default the Dragon12-Plus board is pre-installed with the bootloader (Freescale AN2153.pdf) and the D-Bug12 monitor (Freescale DB12RG4.pdf). In chapters 2 and 3 the AsmIDE is used as the main software tool to develop and debug assembly programs. If you prefer to use Code Warrior IDE for C program development and your board is pre-installed, per your request, with the serial monitor (Freescale AN2548.pdf), **skip the chapters 2 and 3 after installing software from CD.**

People often use different terminologies. In our product manuals, **Download** means to transfer a file from PC to a development board, while **Upload** means to transfer a file from a development board to PC. Through out the manual, **left click** means that you click the left button of the mouse and **right click** means that you click the right button of the mouse.

2.1 Install software from CD:

After downloading the CD from our web site, the installation is automated by double clicking on the **SETUP.BAT**. It will create a folder c:\Dragon12P\examples and copy all example program files from the CD to c:\Dragon12P\examples

If the filename is only shown as **SETUP**, not **SETUP.BAT**, you should change a folder option of the Explorer to show file extension. When a file's extension is hiding, it is hard to know what it is. To have your files to be shown with extensions, click on the TOOL tab in Explorer menu, then click on folder options, then click on view tab, finally un-check the item named 'Hide extensions for knowing file types'.

After the software is successfully installed, you can make a shortcut to AsmIDE.exe on the desktop. It's important to make a shortcut so that its target location is C:\Dragon12P, not c:\Windows\desktop or other locations. First, right click the Start button, then left click "Explorer", left click on C:\Dragon12P, right click on AsmIDE.exe (an application program), left click "Send to" and finally left click "Desktop" (do not click "COPY"). It will create an icon named "shortcut to AsmIDE" on the desktop and you can rename it to Dragon12-Plus. You can double check the target location by right clicking on the icon, then left click on "properties". You should see that the target location is C:\Dragon12P. If you want to make a shortcut for AsmIDE on the Desktop, this is the correct way to do it. If you don't follow this method, you may have a problem running your program. Never drag the AsmIDE.exe to the desktop folder.

The default setting of AsmIDE for the Dragon12-Plus board is created in a text file named c:\Dragon12P\AsmIDE.ini. In the future if you get lost with all the changes, you always can copy this file into the folder named c:\Dragon12P.

2.2 Getting Started

To operate the Dragon12-Plus board, follow steps1 through 5 below:

1. Make sure that the both DIP switches of SW7 must be set in the "low" positions for EVB mode, then plug the AC adapter into a wall outlet and plug the DC female plug of the AC adapter into the DC jack on the lower left side of the Dragon12-Plus board. After power up, the PB7-PB0 LEDs should light up from left to right one at a time, the speaker should chirp once (If the chirp is too soft you can remove the sticker on the speaker to increase the volume) and the LCD should display the following message:

"DRAGON12plus EVB" ; you can display your name on LCD and see details
"D-Bug12 EVB MODE" ; at CDROM\examples\name_displayreadme.txt

If it does not occur, make sure that the Power-On LED indicator is on. The PWR LED is on when VCC (5V) is present. If the PWR LED is off check the output of the AC adapter. It

should be about 12.5V DC without a load (the output DC voltage of the AC adapter is rated for 9V at 500mA, but usually the voltage is much higher without a load).

2. Plug the male end of the DB9 cable into the DB9 connector **P1** on the upper left side of the Dragon12-Plus board and plug the female end of the DB9 cable into COM1 or COM2 port on your PC. The DB9 connector P2 on the lower left side of the board is the MC9S12DG256's SCI1 port that can be used by a user's program.
3. To invoke the AsmIDE, you can right click the Start button, then left click "Explorer", left click on C:\Dragon12P and finally, double left click on AsmIDE.exe. If you have created a shortcut icon on the desktop, just double click the AsmIDE icon on the desktop.
4. The AsmIDE is simple and very easy to use. You only need to use three commands from the AsmIDE for your HCS12 development work. Use the File command to edit your source code, the Build->Assemble command to assemble your source code, and the Build->Download command to download an s19 file to the Dragon12-Plus board.
5. If your PC has a COM port output (it's a 9-pin male DB9 connector), you don't need a USB to RS232 converter. Usually the PC COM port will be COM1 or COM2. For setting the COM port of the AsmIDE, you can click through View-> Option->Terminal Window Options menu, then select the correct COM port and skip the step 6.
6. If your PC does not have a COM port output, you have to use a USB to RS232 adapter, the COM port number that the AsmIDE uses must match the USB-to-Serial COM port number that is assigned by Windows O/S. Windows O/S assigns the USB-to-Serial COM port number randomly and it does not know which COM port number that AsmIDE is going to use. In order to find the USB-to-Serial COM port number, you can click through control panel -> systems -> hardware -> device manager -> ports, the USB-to-Serial COM port number will appear (In Windows Vista, you left click on Start, right click on Computer, left click on propriety, then Device Manager and then Continue).

For setting the COM port of the AsmIDE to match that USB-to-Serial COM port number, you can click through View-> Option->Terminal Window Options menu, then select the correct COM port from COM1 to COM8.

7. Also, set the COM port options at 9600, N, 8,1, and check the "enable the terminal window" box.
8. After reset, the D-Bug12 monitor defaults baud rate at 9600 and and Hyperbaud function is disabled. If Hyperbaud function is enabled, the Hyperbaud toolbar button sends the BAUD 57600 command to the D-Bug12 monitor, and then it also changes the serial port to the 57600 baud rate. **IMPORTANT:** When you reset your board it will go back to 9600 baud and you will see characters 'aaaaaaaa' on the screen. You will need to press the Hyperbaud button once to return AsmIDE to 9600 baud, and press it again to get 57600 baud. To stay at the 57600 baud all the time, you need to press the Hyperbaud button twice after every reset. The Hyperbaud function is disabled by default and it should only be used by an experienced user, not a beginner.
9. You can program text values for function keys to be sent from the terminal window. Some function keys are pre-programmed, but you can change it any time in configuration options (View->Options->Terminal Func Keys).

In the View->Option->Assembler menu, make sure that the chip family is **68HC12**, not 68HC11. If you would like to use your own assembler, you can replace the as12.exe with the name of your own assembler.

10. The screen is divided into two windows. The top window is for editing your source code and the bottom window is shared by the **message window** and the **terminal window**.

If the terminal options are set correctly, you should see the following prompt every time the reset button on the Dragon12-Plus board is pressed. If you do not see this, the bottom window may be set for message window. Sometime it's a little confusing when terminal window is disabled and the message window does not display what you have typed. In order to enable terminal window you have to click the terminal button in the bottom window to enable the terminal window display, then move the cursor to any location in the terminal window and click the left button on the mouse. After seeing a solid block cursor flashes, press the <Enter> key and it will enable the terminal window.

```
D-Bug12 v4.0.0b32
Copyright 1996 - 2005 Freescale Semiconductor
For Commands type "Help"
>
```

2.3 Test Hardware:

To help users get up and running, the Dragon12-Plus board comes with many fully debugged, some fairly advanced ready-to-run sample programs including source code, not just "Hello World" type demo programs. The hardware test program, test.asm, simultaneously scans the keypad, plays a song, multiplexes the 4 LED seven segment display, changes display brightness by adjusting the trimmer pot and detects an object by using the IR transceiver as a proximity sensor.

All sample programs must be run from RAM in EVB mode. In order to run the test program in EVB mode, the both DIP switches of SW7 must be set in the "low" positions to match the picture above the SW7.

The steps to run your first sample program are as follows:

1. Click the File button to open the test.asm from c:\Dragon12P\examples. After the test.asm is loaded into the AsmlIDE window, you can view instructions of how to test all hardware on the Dragon12-Plus board.
2. Click the Build button to assemble code and generate the test.s19 file. This is how you normally generate an s19 file. You can omit this step, because the test.s19 is already on your hard disk.
3. Press the reset button on the board, you will see:

```
D-Bug12 v4.0.0b32
Copyright 1996 - 2005 Freescale Semiconductor
For Commands type "Help"
>
```
4. Type "LOAD", then hit <Enter> key.
5. Click the Build button. Select Download option and locate the file 'test.s19' for downloading. If it prompts you with the "save changes?" message, you can ignore that message and click the "No" answer.
6. After download is done, type "G 2000" and hit <Enter> key to run the test program.

All sample programs on the CD are developed in RAM. You can try to run a different example program later after you have finished reading this manual. You should always press the reset button before downloading a new program, because the new program may not work if an interrupt was enabled by a previous program.

All example programs are fully debugged, so the assembler won't generate an error. If you have an error, even a warning error, in your program, you must correct it before it can generate an s19 file.

3.1 Bootloader and D-Bug12 Monitor

The MC9S12DG256 on the Dragon12-Plus board is pre-loaded with bootloader and D-Bug12 monitor firmware and it will operate in 4 different modes depending on the setting of the 2-position DIPswitch, SW7. After power up or reset, the MC9S12DG256 will read the PAD0 and PAD1 to decide which mode to boot up.

The bootloader (**AN2153.PDF**), the D-Bug12 reference guide (**DB12RG4.PDF**) and the MC9S12DG256 data book (**MC9SDG256.PDF**) are the most important documentations. They can be found on the folder named C:\Dragon12P\document after software installation. The HCS12 instruction set, register map and memory map can be found on page 26, 65 and 120 of the data book, respectively.

The new D-Bug12 V4.x is much different and much larger (about 60K) than old D-Bug12 V2.x. The \$C000-\$EFFF are just a part of the monitor, In 16-bit S1 record they are \$C000-\$EFFF. In 24-bit S2 record, they are \$FC000-FEFFF (ppage=\$3F). Since the ppage register deals with the 16K window \$8000-\$BFFF the addresses \$C000-\$FFFF are not affected by the ppage. The other part of the monitor is at C0000-C87FF (16K window \$8000-\$BFFF when ppage=\$30,\$31 and \$32). See details on page 20 of the app note AN2153 or page 71 of the D-Bug12 v4 reference guide on the CD.

3.1.1 EVB mode: PAD1=0, PAD0=0.

This is the standard debug environment running on the MC9S12DG256 for on-chip RAM or EEPROM based code development. Using an IDE program to view and modify registers and memory locations, you may set breakpoints, single step through programs, and assemble and disassemble code as you would in a BUFFALO monitor based Freescale 68HC11 EVB. It gives you 12K RAM and 3K EEPROM to develop and debug your code. You must place your interrupt vectors at \$3E00-\$3E7F, because real interrupt vector addresses are taken by bootloader, bootloader and D-Bug12 monitor will redirect interrupts to the RAM interrupt vector table at \$3E00-\$3E7F.

After booting up in this mode, the LCD should display the following message:

```
"DRAGON12plus EVB"  
"D-Bug12 EVB MODE"
```

and you should see the following message on PC screen:

```
D-Bug12 v4.0.0b32  
Copyright 1996 - 2005 Freescale Semiconductor  
For Commands type "Help"  
>
```

Typing "help" then <Enter> will display a list of available commands.

In this mode, you **cannot** erase or program on-chip flash memory.

If the D-Bug12 monitor is erased, the LCD will display the following message after reset:

```
"DRAGON12plus EVB"  
" D-Bug12 ERASED "
```

You can use bootloader to re-program D-Bug12 monitor into flash memory.

Note: Some user may accidentally erase D-Bug12 monitor in bootloader mode, so it is important to know how to re-program D-Bug12 monitor in bootloader mode.

3.1.2 Jump-to-EEPROM mode: PAD1=0, PAD0=1

This mode enables the MC9S12DG256 to jump directly to the internal EEPROM at location \$0400 upon reset.

This mode makes the MC9S12DG256 a replacement for the old 68HC811E2 microcontroller, but it also gives you 3K EEPROM instead of 2K EEPROM with the 68HC811E2. The bus speed is 4MHz, one half of the crystal frequency by default, the PLL function must be initialized by user's code for a higher bus speed, because the D-Bug12 monitor firmware that boosts bus speed to 24 MHz is bypassed. If you need to auto start your code upon reset, the procedure is available in the folder named eeprom_programming.

After booting up in this mode, the LCD should display the following message:

“DRAGON12plus EVB”
“ JUMP TO EEPROM ”

3.1.3 BDM POD mode: PAD1=1, PAD0=0

In this BDM POD mode, the D-Bug12 firmware acts as a master to access all target MCU resources on the target board (another Dragon12-Plus board) via the BDM port in a non-intrusive manner. It becomes a BDM that will have all the features that a standard BDM has in debugging the target MCU. Also, it gains all the features a programmer has for programming the flash memory of the MCU on the target board (another Dragon12-Plus board).

To use the master board as a programmer, you need a 6-pin ribbon cable to connect from the BDM OUT of the master board to the BDM IN of the target board (make sure that the orientation of the cable is correct). You don't have to provide the power to both boards, but only to one board. The master board communicates to a PC COM port while the target board does not need to be connected to a PC COM port.

After booting up in this mode, the LCD should display one of the following two messages:

If the D-Bug12 monitor is erased, the LCD will display the following message after reset:

“DRAGON12plus EVB”
“POD-Bug12 ERASED”

Otherwise it will display:

“DRAGON12plus EVB”
“ BDM POD MODE ”

and you should see the following message on PC screen:

Can't Communicate With Target CPU

- 1.) Set Target Speed (48000 KHz)
- 2.) Reset Target
- 3.) Reattempt Communication
- 4.) Erase & Unsecure
- ?

You first must set the target speed with the choice 1). After entering the first choice, you will be prompted to enter the target speed. It's the crystal frequency, not the bus speed that is boosted up by the on-chip PLL. After a reset, before the PLL is enabled, the target

MC9S12DG256 is running from the crystal frequency, not the PLL frequency. Enter 8000 for the target speed. After the correct speed is entered, the master will try to communicate with the target board. If it's not successful, enter choice 2) to reset the target board.

Can't Communicate With Target CPU

- 1.) Set Target Speed (8000 KHz)
 - 2.) Reset Target
 - 3.) Reattempt Communication
 - 4.) Erase & Unsecure
- ? 1

Enter Target Crystal Frequency (kHz): 8000

Can't Communicate With Target CPU

- 1.) Set Target Speed (8000 KHz)
 - 2.) Reset Target
 - 3.) Reattempt Communication
 - 4.) Erase & Unsecure
- ? 2

When the communication is established, you will see the following:

```
D-Bug12 v4.0.0b32
Copyright 1996 - 2005 Freescale Semiconductor
For Commands type "Help"
```

```
S>
```

You will notice that the debug prompt is "S>" in the POD mode, not just a ">" in the EVB mode. The S> tells that this is the POD mode and the MC9S12DG256 on target (slave board) is stopped. Sometimes the prompt could be a "R>" that means the target MCU is running. If you see the "R>", just type "reset" then <Enter> to reset the target and it will come back to the "S>" prompt.

```
R>Reset <Enter>
S>
```

Note: The initial communication in POD mode does not always work smoothly and sometimes the PC screen would only display an incomplete sign-on message. You need to re-start it all over again by pressing reset buttons on both master board and target board, then press the Enter key on PC keyboard. You cannot go to the next step until PC screen shows the prompt 's>'.

In order to program the flash memory, you have to erase it by using the FBULK command.

```
S>fbulk <Enter>
S>
```

When the prompt "s>" returns, the FBULK command has already erased all of the flash memory contents of the target MC9S12DG256 including the bootloader. If it returns with a message "Flash or EEPROM Failed To Erase" the MC9S12DG256 is defective.

Now we are going to program the bootloader and the D-Bug12 into the flash memory of the target MC9S12DG256.

Before we actually program the flash memory, we must understand there are two different types of s-record file that can be generated by compilers and assemblers.

An s1-record uses a 16-bit starting address field while an s2-record uses a 24-bit starting address field.

With the bootloader and the D-Bug12 programmed in the flash memory, the target board now becomes a true development board. That's how we program the board before we ship it. Your Dragon12-Plus board actually becomes a programmer. You can then repeat above steps as many times as you want. Just unplug the 6-pin BDM cable from the target board, and then plug it into a new target board to program its flash memory with these two files. You even don't have to turn off the power while doing this.

For your convenience, we combined both the bootloader and the D-Bug12 monitor into a single s2 file named **Boot_DBug12v32_DR12P_8MHz.s29**. In case you need to update both of them, you can download this combined file.

The D-Bug12 monitor is an application program runs from the bootloader. If you program the D-Bug12 portion of flash memory with your application program, your program will run automatically in EVB mode after power up or reset. When running your code instead of the D-Bug12 monitor, the bus speed is 4MHz, one half of the crystal frequency by default. The PLL function must be initialized by your code for a higher bus speed, because the D-Bug12 monitor firmware was not in flash memory anymore. For your convenience, we include a PLL code template in chapter 7.

If you need to auto start your code upon reset, the procedure is available in the folder named flash_programming.

3.1.4 BOOTLOADER mode: PAD1=1, PAD0=1

This bootloader allows you to erase/program flash memory and erase EEPROM. It is mainly used to program the D-Bug12 monitor into flash memory or download a user's fully debugged code into the D-Bug12 portion of flash memory. The latter allows the board to be operated in EVB mode and start your code every time the board is turned on or reset.

When you program your code into the D-Bug12 portion of flash memory, it wipes out the D-Bug12 monitor. You can restore it any time, just as if you were downloading another application program since the bootloader is not erased. You can erase and program the D-Bug12 monitor portion of the flash memory of the MC9S12DG256 on its own board in bootloader mode, but you cannot erase and program bootloader by itself. **The bootloader can only be erased by an external BDM via BDMIn port.**

After booting up in this mode, the LCD should display the following message:

```
“DRAGON12plus EVB”  
“  BOOT LOADER  ”
```

and you should see the bootloader menu on PC screen:

MC9S12DG256 bootloader menu:

- a) Erase Flash
- b) Program Flash
- c) Set Baud Rate
- d) Erase EEPROM
- ?

The option a) will erase the D-Bug12 portion of flash memory, not the bootloader itself.

The option b) will program the D-Bug12 portion of flash memory, not the bootloader itself.

The file to be programmed into flash memory must be an s2-record file. If your assembler and compiler generate s1-record files only, you must convert an s1-record file to an s-2 record file before programming flash memory with the bootloader.

The option c) will set a new baud rate.
The option d) will erase all on-chip EEPROM.

Note: Some users may accidentally erase the D-Bug12 monitor when entering this mode, so it is important to know how to re-program the D-Bug12 monitor.

To program flash memory with the D-Bug12 monitor:

1. Enter the option a) to erase D-Bug12 portion of flash memory. Wait until the bootloader menu re-appears after flash memory is erased.
2. Enter the option b), the bootloader will wait for your file. **Do not type** any thing on keyboard.
3. Click the Build button, select the Download option, and select the file named **DBug12v32_DR12P_8MHz .s29** located in the folder named "D-Bug12_Monitor" for downloading. You should see the following on the screen:

```
*****  
*****  
*****  
*****  
*****
```

4. It will take 3 minutes to program the D-Bug12 at 9600 baud rate and the bootloader menu will reappear after the D-Bug12 monitor is successfully programmed into flash memory.

3.2 Making a simple assembly program in RAM:

We are using AsmIDE as a terminal program and the following instructions to create your first assembly program. If you are using a different terminal program, the instructions may vary.

The steps to create your first program are as follows:

1. Click the **File** button to open a new file.

In assembly language, you specify the starting address of your CODE by an **ORG** statement.

You can start the data RAM at address \$1000 with the statement `org $1000` followed by RAM variables, as shown by:

```
org    $1000  
  
count: rmb  1      ; reserve one byte of RAM for temp storage  
temp:  rmb  2      ; reserve two bytes of RAM for temp storage
```

If your program is small, say less than 4K, you can start your program at address \$2000 with the statement `org $2000` followed by your program, as shown by:

```
org    $2000
```

It will assemble your source program and generate hex code within 4K locations from \$2000 to \$2FFF.

Here is a very simple program, but it's complete. It will flash the PBO LED at 2Hz when it's running. The RAM byte named 'counter' is added for demonstrating how a RAM data byte is used in a user program. In this simple program it's not really necessary, because the accumulator A can be used as the RAM byte 'counter'.

For a good programming practice, you should always place the lds instruction in the first line of your code.

```

#include    reg9s12.h
REGBLK:   equ    $0000
STACK:    equ    $2000          ; do not use $4000
;
          org    $1000
counter:   rmb    1

          org    $2000          ; program code
start:     lds    #STACK
          ldx    #REGBLK

          ldaa   #$ff
          staa   ddrj,x        ; make port J an output port
          staa   ddrb,x        ; make port B an output port
          staa   ddrp,x        ; make port P an output port
          staa   ptp,x         ; turn off 7-segment LED display

          clr    ptj,x         ; make PJ1 low to enable LEDs
back:      clr    portb,x      ; turn off PB0
          jsr    d250ms        ; delay 250ms
          inc    portb,x      ; turn on PB0
          jsr    d250ms        ; delay 250ms
          jmp   back

*
d250ms:    ldaa   #250         ; delay 250 ms
          staa   counter

delay1:    ldy    #6000        ; 6000 x 4 = 24,000 cycles = 1ms
delay:     dey
          bne    delay        ; this instruction takes 1 cycle
          dec    counter      ; this instruction takes 3 cycles
          bne    delay1       ; not 250ms yet, delay again
          rts

          end

```

2. Click File button, select Save option to save your assembly source file. Save your file frequently while editing. If you are creating a new file and giving the file a name to save, enter the file name including file extension, such as "Flash_PB0.asm", not just "Flash_PB0".
3. Click Build button, select Assemble option, or click the assembler button on the toolbar to assemble your code and generate an s19 file. If the assembler detects an error, the error message will show the line numbers of your source code that caused the error. You have to correct all errors in your program.
4. Go to the line and correct the errors and go back to step 3 until there are no errors.
5. Press the reset button on the board, you will see:

```

D-Bug12 v4.0.0b32
Copyright 1996 - 2005 Freescale Semiconductor
For Commands type "Help"
>

```

6. Type "LOAD" and then hit <Enter> key
7. Click Build button, select Download option and locate the file named 'Flash_PB0.s19'" for downloading. After download is done, type "G 2000" and hit <Enter> key to run the program.

For your convenience, we have included this sample program on the CD.

3.3 Software development

3.3.1 Use on-chip 12K RAM for software development in EVB mode.

You can download your s19 file into the RAM and debug it with the D-Bug12 monitor in this mode. You must place your interrupt vectors at \$3E00-\$3E7F, because real interrupt vector addresses are taken by the bootloader. The bootloader and the D-Bug12 monitor will redirect interrupts to the RAM interrupt vector addresses at \$3E00-\$3E7F

Because RAM will lose its contents after power off, you have to load your program every time after power-up. In the beginning of your program, you must initialize the interrupt vectors at \$3E00-\$3E7F.

In all sample programs, the user program code locations are at \$2000-\$3FFF. The user data RAM locations are at \$1000-\$1FFF. The 64 RAM interrupt vector addresses are at \$3E00-\$3E7F.

The 64 RAM interrupt vector addresses (128 bytes of RAM) are assigned by the D-Bug12 monitor to different interrupt sources. The listing of interrupt sources is show on chapter 8.

3.3.2 Use on-chip 3K EEPROM for testing your code in EVB mode.

If your program is small enough to fit into a 3K range, then you can download your code into the EEPROM. In this way, your program can be auto started from \$0400 upon reset. You cannot set software breakpoints and single step in the EEPROM in EVB mode, so it makes sense to do development work in the RAM. When your code is completely debugged, then re-assemble or re-compile it at \$0400 and download the final s19 file into the EEPROM for the auto start feature.

Like the RAM-based development, your interrupt vectors are at \$3E00-\$3E7F. In the beginning of your program, you must initialize the interrupt vectors at \$3E00-\$3E7F.

3.3.3 Use on-chip flash for testing your code in BOOTLOADER mode.

In this mode, you download your program directly into on-chip flash memory. You first erase the D-Bug12 monitor portion of flash memory, and then program that portion of the flash memory by downloading your application program code in an s29 file. Your program will replace the D-Bug12 monitor in the flash memory. The bootloader portion of the flash memory remains intact. To run your code, set the mode switch SW 7 to EVB mode, then press the reset button. It usually runs the D-Bug12 monitor, but now it runs your program. The flash memory is non-volatile like the EEPROM. Your code will run every time the board is turned on or reset.

The bootloader redirects interrupts to \$EF80-\$EFFF. The D-BUG12 is not present and the interrupt vectors of your program are at \$EF80-\$EFFF. The addresses \$EFFE and \$EFFF contains the starting address of your program.

In order to program the MC9S12DG256 flash memory, you must program an even number of bytes and begin on an even address boundary for each s-record. If any one s-record in the file contains an odd number of bytes or begins with an odd address, the flash memory cannot be programmed. If your assembler or compiler cannot generate the even format, you must use the Freescale s-record conversion utility **sreccvt.exe** to convert your odd format to the even format by using the following command line:

```
Sreccvt -m c0000 ffff 32 -of f0000 -o test.s29 test.s19
```

It will create a new file named test.s29 that has the even format and can be programmed into flash memory. For your convenience, the sreccvt.exe is included in the folder named CDRROM\document\Sreccvt-GUI.

Chapter 4: Hardware Descriptions

The crystal frequency is 8 MHz and usually it will result in a 4 MHz bus speed, but on this board the MC9S12DG256's internal PLL boosts the bus speed up to 24 MHz.

The circuit is designed in such way that the value of all resistors and capacitors are not critical, with the exception of R10 and C36, which determine the 38KHz for IR transmitter.

4.1 LEDs:

Each port B line is monitored by a LED. In order to turn on port B LEDs, the PJ1 (pin 21 of MC9S12DG256) must be programmed as output and set for logic zero.

4.2 DIP switch and pushbuttons:

Port H is connected to an 8-position DIP switch. The DIP switch is connected to GND via the RN9 (eight 4.7K resistors), so it's not dead short to GND. When port H is programmed as an output port, the DIP switch setting is ignored, but for the best result all 8 DIP switches should be open (at the up positions).

4.3 7-Segment LED multiplexing

There are 4 digits of 7-segment LEDs on the Dragon12-Plus board. The type of the 7-segment LED on board is called common cathode. In an individual digit, all anodes are driven individually by an output port and all cathodes are internally connected together.

Before sending a number to a 7-segment LED, the number must be converted to its corresponding 7-segment code depending how the 7-segment display is connected to an output port.

The Dragon12-Plus board uses port B to drive 7-segment anodes and uses PP0-PP3 to drive common cathodes. We will explain how to multiplex 7-segment by displaying the number 1234 on the display.

By convention, the 7 segments are called segment A, B, C, D, E, F and G. Their locations in the display are shown below:

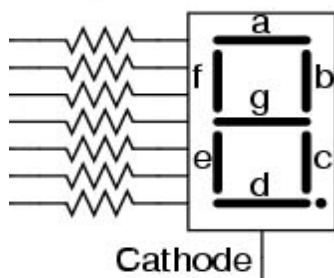

The segment A, B, C, D, E, F, G and Decimal Point are driven by PB0, PB1, PB2, PB3, PB4, PB5, PB5 and PB7, respectively. The hex value of the segment code is shown in the following table:

Number	DP	G	F	E	D	C	B	A	Hex Value
1	0	0	0	0	0	1	1	0	\$06
2	0	1	0	1	1	0	1	1	\$5B
3	0	1	0	0	1	1	1	1	\$4F
4	0	1	1	0	0	1	1	0	\$66

The schematic for multiplexing 4 digits is shown below. The two of the digits at the right are deliberately placed upside down and the hardware connections compensate for this configuration. The reason for the upside down digits is to place two decimal pointers on the middle as a colon for a clock display.

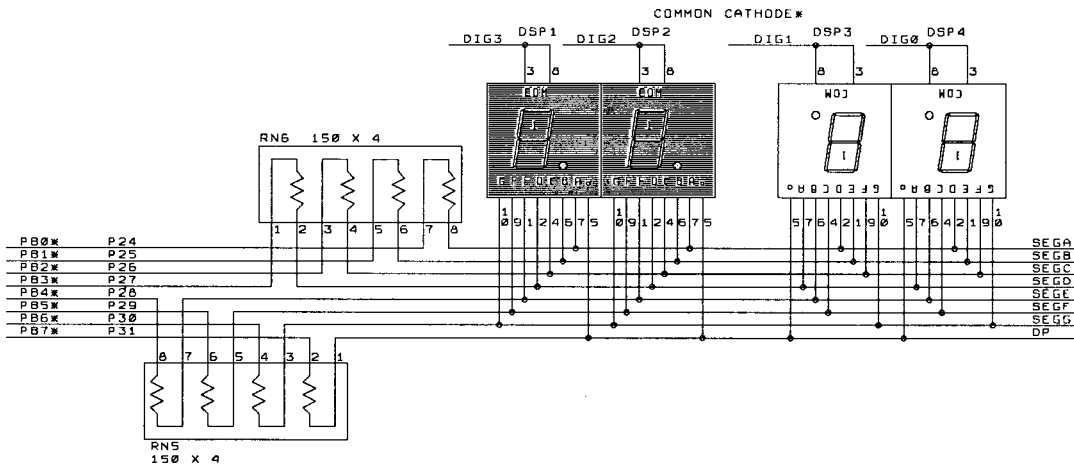

The digit 3, 2, 1, and 0 are driven by PP0, PP1, PP2 and PP3, respectively. The 7-segment LED is turned on one at a time at 250 Hz refresh rate. It's so fast that our eyes will perceive that all 4 digits are turned on at the same time. To display the number 1234 on the 7-segment display, the following steps should be taken:

1. Output \$06 to port B, set PP0 low and PP1, PP2, and PP3 high. The number 1 is shown on the digit 3 (the leftmost digit), but other 3 digits are turned off.
2. Delay 1ms.
3. Output \$5B to port B, set PP1 low and PP0, PP2, and PP3 high. The number 2 is shown on the digit 2, but other 3 digits are turned off.
4. Delay 1ms.
5. Output \$4F to port B, set PP2 low and PP0, PP1, and PP3 high. The number 3 is shown on the digit 1, but other 3 digits are turned off.
6. Delay 1ms.
7. Output \$66 to port B, set PP3 low and PP0, PP1, and PP2 high. The number 4 is shown on the digit 0 (the rightmost digit), but other 3 digits are turned off.
8. Delay 1ms.
9. Go back to step 1.

4.4 Keypad:

Port A is an 8-bit bi-directional port. Its primary usage is for a 4X4 keypad. If the port is not used for the keypad, it can be used as a general-purpose I/O.

The schematic for the keypad connections is shown below:

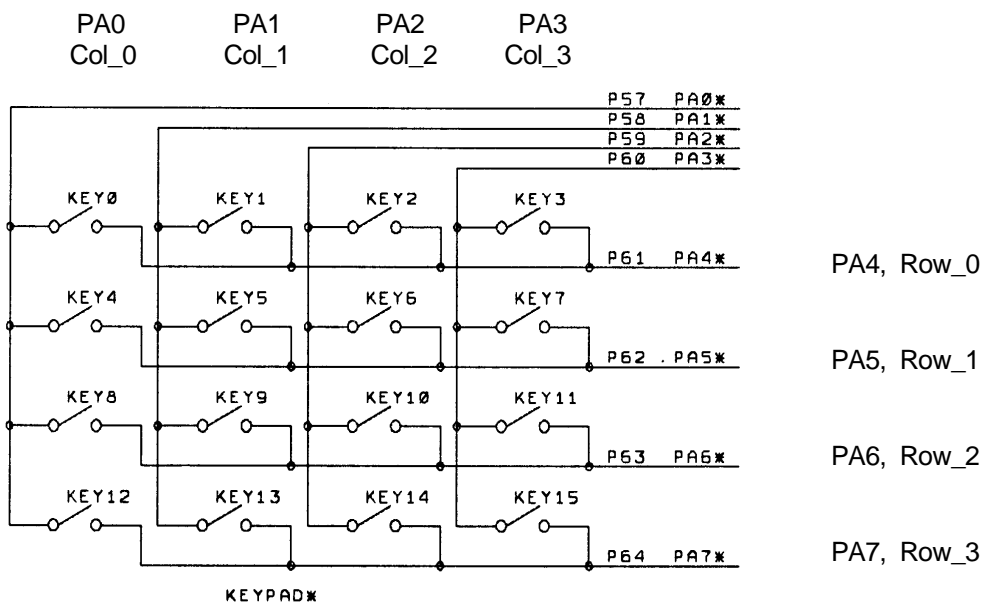

Keypad connections:

- PA0 connects COL0 of the keypad
- PA1 connects COL1 of the keypad
- PA2 connects COL2 of the keypad
- PA3 connects COL3 of the keypad
- PA4 connects ROW0 of the keypad
- PA5 connects ROW1 of the keypad
- PA6 connects ROW2 of the keypad
- PA7 connects ROW3 of the keypad

Keypad scan routine sets PA3 low and PA0, PA1, PA2 high, then tests PA4-PA7.

- If no key is down, PA4-PA7 remain high.
- If PA7 = low, the key 15 is down.
- If PA6 = low, the key 14 is down.
- If PA5 = low, the key 13 is down.
- If PA4 = low, the key 12 is down.

Keypad scan routine sets PA2 low and PA0, PA1, PA3 high, then tests PA4-PA7.

- If no key is down, PA4-PA7 remain high.
- If PA7 = low, the key 11 is down.
- If PA6 = low, the key 10 is down.
- If PA5 = low, the key 9 is down.
- If PA4 = low, the key 8 is down.

Keypad scan routine sets PA1 low and PA0, PA2, PA3 high, then tests PA4-PA7.

- If no key is down, PA4-PA7 remain high.
- If PA7 = low, the key 7 is down.
- If PA6 = low, the key 6 is down.
- If PA5 = low, the key 5 is down.
- If PA4 = low, the key 4 is down.

Keypad scan routine sets PA0 low and PA1, PA2, PA3 high, then tests PA4-PA7.

If no key is down, PA4-PA7 remain high.

If PA7 = low, the key 3 is down.

If PA6 = low, the key 2 is down.

If PA5 = low, the key 1 is down.

If PA4 = low, the key 0 is down.

4.5 LCD display

Port K is an 8-bit bi-directional port. It's used for the LCD display module. If the port is not used for the LCD display, it can be used as a general-purpose I/O port.

The pinouts of J11 and J12 are as follows:

Pin 1	GND	
Pin 2	VCC (5V)	
Pin 3	Via a 220 Ohm resistor to GND	
Pin 4	PK0	RS pin for LCD module
Pin 5	PK7	R/W pin for LCD module
Pin 6	PK1	EN pin for LCD module
Pin 7	Not used	
Pin 8	Not used	
Pin 9	Not used	
Pin 10	Not used	
Pin 11	PK2	DB4 pin for LCD module
Pin 12	PK3	DB5 pin for LCD module
Pin 13	PK4	DB6 pin for LCD module
Pin 14	PK5	DB7 pin for LCD module
Pin 15	Via a 22 Ohm resistor to VCC	LED backlight for LCD module
Pin 16	GND	

Please notice that PK2-PK5 (not PK4-PK7) are used to drive DB4-DB7 of the LCD module.

The LCD module is hardwired for write-only operation. Experienced user can cut a trace between pin 2 and pin 3 of J5 on solder side, then install a 3-pin male header on J5 to make it for both read and write operations. The jumper on the J5 can be used to select the Read/write function of the LCD module. It's write-only if the jumper is placed in the "right" position. It supports both the read and write functions if the jumper is placed in the "left" position.

4.6 Logic probe

An on-board logic probe LED is connected to pin 47 of header H4 and can be used to monitor a high or low status at any point of the circuit as a logic probe. Pin 47 of U10 (MC9S12DG256) is not connected to header H4.

4.7 Trimmer pot

The VR2 is connected to the AN07 input of the ADC port via J17, but the trace at J17 can be cut if AN07 must be used by target circuits.

4.8 Dual Digital-to-Analog Converters (DACs)

The on-board 2-ch, 10-bit DAC is installed for learning SPI communication. It converts a digital binary code to an analog signal so a program can generate different waveforms from the DAC.

The DAC being used on the board is LTC1661. Its analog output, OUTA, is provided on the pin between the headers H7 and H8. The other analog output, OUTB, is provided on the pin between the headers H1 and H2. A good application is to connect a DAC output to an ADC input, so a user can send a binary code to the DAC and read the code back from the ADC.

4.9 Speaker

The speaker is a 5V audio transducer and it can be driven by PT5, Output Comparator 5, or PP5, PWM 5, or the output B of the DAC LTC1661. The jumper on J26 is preset for the PT5 at factory and all sample programs on the CD will drive the speaker via PT5.

During reset, the bootloader or the serial monitor will generate a chirp via the speaker. If the jumper is not placed for the PT5, the chirp won't happen.

4.10 IR transceiver and 38 KHz oscillator

The U7, CD4093, generates a 38KHz square wave for the IR transmitter. One of the CD4093's gate is used as a 38 KHz oscillator. The value of resistor R10 may vary if the CD4093 is manufactured by a different company.

If the IR transmitter is not used by an application program, the 38 KHz square wave also can be available to the user's circuits on the breadboard. If the pin 4 of J27 is short to ground, the 38 KHz square wave will be present at the pin next to the RESET pin on the header H3. You also can use MM command to force PS3 or PT4 to low to enable the 38 KHz oscillator (U7A).

The IR detector can be used as an object detection sensor. When an object is approach the IR detector, it can reflect the 38 KHz signal from IR transmitter to the detector. Normally the output of the detector is in high state. When a 38 KHz IR signal is detected by the IR detector, the output of the detector goes low.

4.11 Dual RS232 communication ports

Both P1 and P2 DB9 female connectors are configured as **DCE** devices and they can be directly connected to the PC 's COM ports.

The P1 connector is used by SCI0 of the DG256 while the P2 is used by SC1 of the DG256. The D-Bug12 monitor or serial monitor works with SCI0, so the P1 should be connected to a PC's COM port during debugging sessions. The SCI1 can be used by user's application programs. The receiver of the SCI1 can receive signals from many different devices, but only one device at a time, or it will cause a signal collision. The jumper headers J23 and J29 are used to select which device the SCI1 will receive. The J23 selects a signal among your circuits on the breadboard, user RS232, RS485, RF receiver and IR detector. The J29 selects VGA camera. The J23 and J29 cannot have a jumper at the same time. If VGA camera is used, move the jumper from J23 to J29, otherwise move the jumper from J29 to J23.

The 2-pin header above the DB9 connector P1 is connected to the pin 2 and pin 3 of the P1. The correct RS232 level and direction should appear on these two pins during RS232 transmission. They can be checked by a scope for diagnostic purposes.

The Power-ON LED indicator (located above the 9-pin terminal block, T4) also provides another troubleshooting aid. During reset in EVB mode, the PB7-PB0 LEDs will light up from left to right one at a time, and then the D-Bug12 monitor will transmit a sign-on message to PC screen. The positive pulse on the RS232 transmitter signal is sent to the Power-ON LED through D3 and R22. The PWR LED will grow brighter for 100ms. If it does not grow brighter then the U1 (SP232) may be defective.

In summary, whenever the Dragon12-Plus board sends a message or data to PC via SCI0, the PWR LED will grow brighter momentarily.

4.12 RS485 communication port

U5, SN75176, converts the TTL signal from SCI1 to RS485 differential signals and vice versa.

PJ0 (pin 22) of the MC9S12DG256 is used to control the direction of RS485 communication. If PJ0=0, the RS485 port, U9 DS75176, is set as a receiver port. If PJ0=1, the RS485 port, U9 DS75176, is set as a transmitter port.

4.13 External SPI interface

SPI port (J10) pinouts are as follows:

Pin 1	VCC (5V)	Pin 2	VCC (5V)
Pin 3	PM7 (LOAD)	Pin 4	PS4 (SPI DATA IN)
Pin 5	PS7 (STROBE)	Pin 6	PS5 (SPI DATA OUT)
Pin 7	PE1 (/IRQ)	Pin 8	PS6 (CLOCK)
Pin 9	GND	Pin 10	GND

4.14 External I²C interface

I2C port (J2) pinouts are as follows:

Pin 1	VCC (5V)	Pin 2	/IRQ
Pin 3	PM7 (SCL)	Pin 4	PS4 (SDA)
Pin 5	GND		

4.15 All jumper settings

All on-board jumpers:

- J1 Enables the LCD backlight.
- J2 I²C interface
- J3 Connection of the terminating resistor for CAN0. Place a jumper on this header only if you use CAN0. It will save power consumption of the board without the jumper if CAN0 is not used.
- J4 Two channel 10-bit DAC outputs. The output A is also available between PJ6 of H8 and PJ7 of H7. The output B is also available between GND of H1 and PT4 of H2.
- J5 R/W of LCD module. It's hardwired for write-only.
- J6 PP4 PWM output for Robot servo
- J7 PP5 PWM output for Robot servo
- J8 PP6 PWM output for Robot servo
- J9 PP7 PWM output for Robot servo
- J10 SPI connector
- J11 On-board LCD connector for 16x2 LCD
- J12 External LCD connector for a LCD module of any size.
- J13 RS of CAN0 (U2), is connected to VSS
- J14 Connects battery voltage of RTC to low voltage detection. It's not connected.
- J15 Connects light sensor to AN05 of the ADC. It's hardwired.
- J16 Connects SQW of the DS1307 to /IRQ. It's not connected.
- J17 Connects temperature sensor U14 to AN05 of the ADC. It's hardwired.
- J18 VCC for H-bridge driver, U12, SN754410N. H-bridge driver and 7-segment LED display should not be enabled at the same time. Move the jumper from J24 to this header only if H-bridge driver is used. When H-bridge driver is not used, move this jumper back to J24

- J19 Connects the PS3 (TXD1) of SCI1 to all communication hardware (RS232, RS485, RF and IR transceiver) on this development board.

- J20 BDM input
- J21 BDM output, when the board is booted in POD mode
- J22 RS485 direction control by PJ0 (pin22) through this jumper
- J23 SCI1 receiver source select (numbering from top to bottom)
 - 1= SCI1's PS2 receives signal from your circuits on the breadboard via pin 91 of header H7. The pin 91 of the U10 (DG256) is not connected to header H7.
 - 2= SCI1's PS2 receives signal from P2, the DB9 connector for user RS232 port.
 - 3= SCI1's PS2 receives signal from the terminal block T2 for RS485 port.
 - 4= SCI1's PS2 receives signal from the on-board RF receiver.
 - 5= SCI1's PS2 receives signal from the on-board IR detector. This is the default setting.

Note: J23 and J29 cannot have a jumper at the same time.
If a VGA camera is used, move this jumper to J29.
- J24 Enables 7-segment LED display driver U6, 74HC367. 7-segment LED display and H-bridge driver should not be enabled at the same time. If H-bridge driver is used, move this jumper to J18, otherwise leave the jumper on this header.

- J25 DC motor power select. The jumper is placed in the "up" position if motors are powered by the on-board unregulated 9V (VIN). The jumper is placed in the "low" position if motors are powered by external 9V at pin 1 of the terminal block T4.
- J26 Selects speaker driving source. The speaker can be driven by PT5 (OC3), PP5 (PWM) and DAC B.

- J27 IR transceiver control source select
When the jumpers are placed vertically in the “up” positions (labeled with PS2 and PS3), The PS3 (TXD1) of SCI1 drives the IR transmitter and the PS2 (RXD1) of SCI1 receives data from the IR detector. The PS3 and PS2 can be programmed as general I/O lines or a SCI UART.
When the jumpers are placed vertically in the “low” positions (labeled with ‘PT4 and PT3’), the PT4 drives the IR transmitter and the PT3 receives data from the IR detector.
- J28 VGA camera interface.
- J29 SCI1’s PS2 receives signal from VGA camera. J29 and J23 cannot have a jumper at the same time. If VGA camera is not used, move this jumper to J23.
- J30 Mode B select (a solder bridge on solder side), it defaults at 0. Do not change it if developing code in normal single chip mode.
- J31 Mode A select (a solder bridge on solder side), it defaults at 0. Do not change it if developing code in normal single chip mode.
- J32 Mode C select (a solder bridge on solder side), it defaults at 1. Do not change it if developing code in normal single chip mode.
- J33 Input voltage select for the 3.3V regulator U16. LM117. It’s set for the on-board unregulated 9V (VIN).
- J34 Connects PE2 to relay circuit. It’s hardwired.
- J35 Servo motor power select. The jumper is placed in the “left” position if servos are powered by the on-board VCC (5V). The jumper is placed in the “right” position if servos are powered by an external 5V power supply at the terminal block T7.
- J36 X-Y-X Accelerometer module interface or IR distance sensor, GP2D12, interface.
- J37 Bypasses low pass filter of RF receiver. It’s not connected

Eric Engler has published the EmbeddedGNU IDE that supports GNU C compiler and assembler for any 68HC11/HC12/HCS12 boards including our FOX11, EVBplus2, DRAGON12 and MiniDragon+ boards. It's free software under Open Source, GNU GPL License. It's not freeware nor shareware (be aware that some freeware are not free). To download Eric's free tools including the GNU C compiler and assembler please visit his web site at: http://www.geocities.com/englere_geo/
For your convenience, we downloaded the egnu094.zip for you.

The following page shows the exact terms of the license (Mozilla Public License)
http://www.geocities.com/englere_geo/License.txt

The steps to set up the EmbeddedGNU are as follows:

1. Download the GNU GCC compiler from: http://m68hc11.serveftp.org/m68hc11_pkg_zip.php
Select the release 3.1 to download. It has the following components in it:
Gcc 3.3.6
Gdb 6.4
Binutils 2.15
Newlib 1.12.0
2. Run the file that you downloaded to install GNU 68HC11/68HC12 tools into the default directory of C:\usr.
3. Install the EmbeddedGNU on your PC by double clicking on the egnu094.zip. If the egnu094.zip is not on the CD, you can download it from <http://www.ericengler.com/EmbeddedGNU.aspx>
Extract all files into a new directory that you need to create on any hard drive. The name of the new directory can be like c:\egnu094 or d:\egnu094. The EmbeddedGNU.exe and example programs will be located at \egnu094, but your application programs can be located in any other directories.
4. Filename Association.
When you first start EmbeddedGNU.exe it will ask if you want to associate the filename extensions used by EmbeddedGNU with itself. This lets you double-click on a filename and the EmbeddedGNU will be launched to let you edit the file. The default option is to associate ".prj" with EmbeddedGNU. This is the main project file type used by EmbeddedGNU.

You also should choose to associate .c, .h, and .s files with EmbeddedGNU.

WARNING: if you are on WinNT/Win2K/WinXp, then you must be logged in as an administrator to use this option.

Press OK to continue

5. COM Port Selection.
It asks if you want to select your COM port. Say Yes. Select your port in the dropdown box. It defaults to 9600 baud, which is normally correct. Now press OK.
6. Select Option-> Environment Options->AutoDownload, then disable ALL automatic commands.
7. The current egnu094.zip is properly set up with the newest release version 3.1 (GCC 3.3.6). In the future when upgrading to a newer version you have to update the linker's search directory. See help file related version upgrade issues.

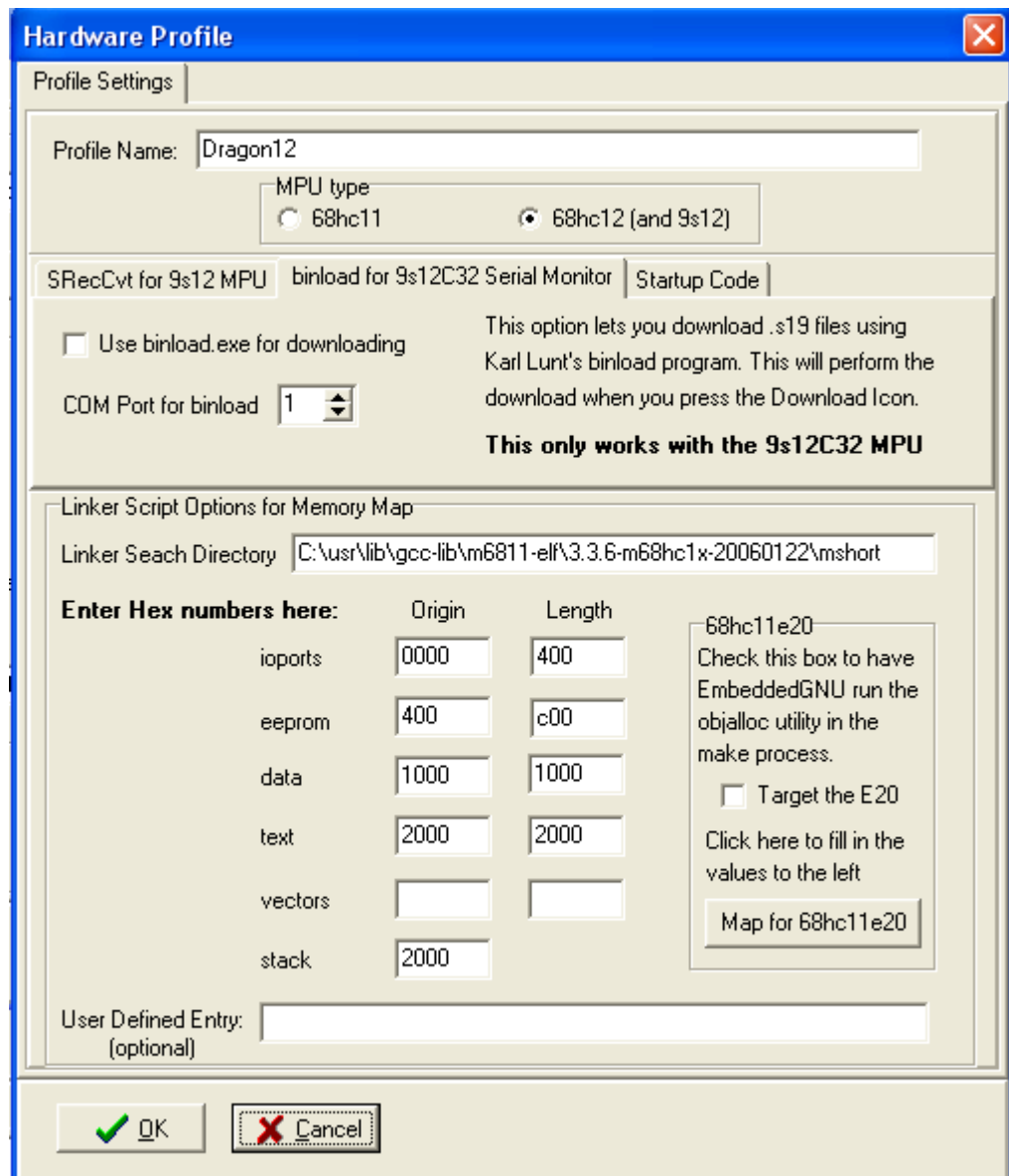

To change the linker search directory (search path) for GNU C compiler toolset you click on options->project options->edit profile. As it can be seen from above Linker Search Directory, the GCC 3.3.6 is installed on C drive.

Some university web sites offer educational resource for the EmbeddedGNU. The following web site provides [A C sample program for the DRAGON12 board using EmbeddedGNU and GCC](#)

York University's CSE4080 computer science project <http://www.gcc-hcs12.com/index.php> provides easy to use open source and GPL type resources for the HCS12 family.

Chapter 6: Code Warrior and Serial monitor

Code Warrior is a very powerful and professional IDE. The main feature of Code Warrior IDE is the source level debugger in assembler and C. Code Warrior Special Edition is a wonderful gift from Freescale to all of us and it's free for educational use. What's more, by Code Warrior supporting serial monitor, they have made it very affordable to support Code Warrior for the OEM.

Freescale has invested millions of dollar into Code Warrior and the current versions work very well. What's more, Freescale knows they will never sell enough copies of Code Warrior to make back what they have invested. They did it to drive chip sales.

As a software developer, the first thing you look at is available tools and what it will cost. There are many companies making MCU chips these days and for the most part they all have about the same features at a similar price. Special Edition Code Warrior sets Freescale apart from others.

Code Warrior IDE does not work with D-Bug12, but it works with serial monitor. Before Freescale created the serial monitor a BDM is needed as an interface between the PC and HCS12. Freescale created the serial monitor for working with Code Warrior to eliminate the cost of a BDM.

Now a student can use the serial monitor with Code Warrior to debug his program and in fact, many universities have been using the serial monitor with Code Warrior without a BDM in their classrooms.

Without spending money on a BDM, a student will be able to spend his savings on purchasing a more advanced trainer, like the Dragon12-Plus board with many on-board peripherals. Purchasing an EVB board that comes with a BDM at a reasonable price, most likely leaves the student with an EVB of only limited functionality.

Some universities use D-Bug12 monitor first, then replace the D-Bug12 monitor with serial monitor to be used with Code Warrior IDE. In this case, a school laboratory only needs to have one BDM or use one Dragon12 Plus board as a BDM POD, to program all students' boards with serial monitor.

To replace bootloader and D-Bug12 monitor with serial monitor, you need a BDM or a BDM POD to perform the task. The procedure to program the on-chip flash memory is shown on page 16. The file name of the latest serial monitor including a self test program for the Dragon12 board is **SM_and_Test_DR12P_8MHz.s29**, which is included in the CD and also available on our web site at:

http://www.evbplus.com/download_hcs12/download_hcs12.html

Some universities use Code Warrior IDE only. In this case, we pre-load the on-chip flash memory with serial monitor.

If your board is pre-loaded with D-Bug12 monitor, the Port B LEDs will light up from **LEFT to RIGHT** one at a time and the speaker will chirp once when the board is turned on. If the chirp is too soft you can remove the sticker on the speaker to increase volume.

If your board is pre-loaded with Serial Monitor the Port B LEDs will light up from **RIGHT to LEFT** one at a time and the speaker will chirp once when the board is turned on. To distinguish RUN mode from LOAD mode, Port B LEDs will light up again from **LEFT to RIGHT** one at a time in RUN mode.

The left DIP switch of SW7 is used to select RUN or downLOAD mode. The left DIP switch is set in the "up" position for RUN mode and in the "low" position for downLOAD mode.

We will add setup procedures for Code Warrior in the future. Our web site provides links to many university web sites and you can visit those web sites for more information.

http://www.evbplus.com/Code_Warrior_hcs12.html

Following is the web site for downloading the free Code Warrior special edition:

<http://www.freescale.com/webapp/sps/site/overview.jsp?nodeId=01272600610BF1>

Following is the web site for downloading the Code Warrior full edition for a 30-day free evaluation:

<http://www.freescale.com/webapp/sps/site/overview.jsp?nodeId=01272600612247>

Chapter 7: PLL code

```
; The crystal frequency on the Dragon12-Plus board is 8 MHz so the default bus speed is
; 4 MHz. In order to set the bus speed high than 4 MHz the PLL must be initialized.
```

```
; You can cut and paste the following code to the beginning of your program.
```

```
; The math used to set the PLL frequency is:
```

```
;  $PLLCLK = CrystalFreq * 2 * (initSYNR+1) / (initREFDV+1)$ 
```

```
; CrystalFreq = 8 MHz on Dragon12 plus board
; initSYNR = 5, PLL multiplier will be 6
; initREFDV = 1, PLL divisor will be 2
;  $PLLCLK = 8 * 2 * 6 / 2 = 48MHz$ 
; The bus speed =  $PLLCLK / 2 = 24 MHz$ 
```

```
start:
```

```
; PLL code for 24MHz bus speed from a 4/8/16 crystal
```

```
sei
ldx #0
bclr clksel,x,%10000000 ; clear bit 7, clock derived from oscclk
bset pllctl,x,%01000000 ; Turn PLL on, bit 6=1 PLL on, bit 6=0 PLL off
ldaa #$05 ; 5+1=6 multiplier
staa synr,x
; ldaa #$03 ; divisor=3+1=4,  $16 * 2 * 6 / 4 = 48MHz$  PLL freq, for 16 MHz crystal
; ldaa #$01 ; divisor=1+1=2,  $8 * 2 * 6 / 2 = 48MHz$  PLL freq, for 8 MHz crystal
; ldaa #$00 ; divisor=0+1=1,  $4 * 2 * 6 / 1 = 48MHz$  PLL freq, for 4 MHz crystal

staa refdv,x
wait_b3: brclr crgflg,x,%00001000 wait_b3 ; Wait until bit 3 = 1
bset clksel,x,%10000000
```

8.1 D-Bug12 utility routines

The AN1280 was written for OLD 68HC12 family. If you happen to use printf routine with your old 68HC12 board you should be aware that I/O utility routines are moved to different addresses in D-Bug12 V4.x.

The address for the printf is \$EE88 and addresses of other I/O routines are listed below:

Function	Description	Pointer Address
<code>far main()</code>	Start of D-Bug12	\$EE80
<code>getchar()</code>	Get a character from SCI0 or SCI1	\$EE84
<code>putchar()</code>	Send a character out SCI0 or SCI1	\$EE86
<code>printf()</code>	Formatted Output - Translates binary values to characters	\$EE88
<code>far GetCmdLine()</code>	Obtain a line of input from the user	\$EE8A
<code>far sscanhex()</code>	Convert an ASCII hexadecimal string to a binary integer	\$EE8E
<code>isxdigit()</code>	Checks for membership in the set [0..9, a..f, A..F]	\$EE92
<code>toupper()</code>	Converts lower case characters to upper case	\$EE94
<code>isalpha()</code>	Checks for membership in the set [a..z, A..Z]	\$EE96
<code>strlen()</code>	Returns the length of a null terminated string	\$EE98
<code>strcpy()</code>	Copies a null terminated string	\$EE9A
<code>far out2hex()</code>	Displays 8-bit number as 2 ASCII hex characters	\$EE9C
<code>far out4hex()</code>	Displays 16-bit number as 4 ASCII hex characters	\$EEA0
<code>SetUserVector()</code>	Setup user interrupt service routine	\$EEA4
<code>far WriteEEByte()</code>	Write a data byte to on-chip EEPROM	\$EEA6
<code>far EraseEE()</code>	Bulk erase on-chip EEPROM	\$EEAA
<code>far ReadMem()</code>	Read data from the M68HC12 memory map	\$EEAE
<code>far WriteMem()</code>	Write data to the M68HC12 memory map	\$EEB2

Fig 8-1: D-Bug12 utility routines

8.2 Interrupt vector table

Table 5-1 Interrupt Vector Locations

Vector Address	Interrupt Source	CCR Mask	Local Enable	HPRIO Value to Elevate
\$FFFE, \$FFFF	Reset	None	None	–
\$FFFC, \$FFFD	Clock Monitor fail reset	None	PLLCTL (CME, SCME)	–
\$FFFA, \$FFFB	COP failure reset	None	COP rate select	–
\$FFF8, \$FFF9	Unimplemented instruction trap	None	None	–
\$FFF6, \$FFF7	SWI	None	None	–
\$FFF4, \$FFF5	XIRQ	X-Bit	None	–
\$FFF2, \$FFF3	IRQ	I-Bit	IRQCR (IRQEN)	\$F2
\$FFF0, \$FFF1	Real Time Interrupt	I-Bit	CRGINT (RTIE)	\$F0
\$FFEE, \$FFEF	Enhanced Capture Timer channel 0	I-Bit	TIE (C0I)	\$EE
\$FFEC, \$FFED	Enhanced Capture Timer channel 1	I-Bit	TIE (C1I)	\$EC
\$FFEA, \$FFEB	Enhanced Capture Timer channel 2	I-Bit	TIE (C2I)	\$EA
\$FFE8, \$FFE9	Enhanced Capture Timer channel 3	I-Bit	TIE (C3I)	\$E8
\$FFE6, \$FFE7	Enhanced Capture Timer channel 4	I-Bit	TIE (C4I)	\$E6
\$FFE4, \$FFE5	Enhanced Capture Timer channel 5	I-Bit	TIE (C5I)	\$E4
\$FFE2, \$FFE3	Enhanced Capture Timer channel 6	I-Bit	TIE (C6I)	\$E2
\$FFE0, \$FFE1	Enhanced Capture Timer channel 7	I-Bit	TIE (C7I)	\$E0
\$FFDE, \$FFDF	Enhanced Capture Timer overflow	I-Bit	TSRC2 (TOF)	\$DE
\$FFDC, \$FFDD	Pulse accumulator A overflow	I-Bit	PACTL (PAOVI)	\$DC
\$FFDA, \$FFDB	Pulse accumulator input edge	I-Bit	PACTL (PAI)	\$DA
\$FFD8, \$FFD9	SPI0	I-Bit	SP0CR1 (SPIE, SPTIE)	\$D8
\$FFD6, \$FFD7	SCI0	I-Bit	SC0CR2 (TIE, TCIE, RIE, ILIE)	\$D6
\$FFD4, \$FFD5	SCI1	I-Bit	SC1CR2 (TIE, TCIE, RIE, ILIE)	\$D4
\$FFD2, \$FFD3	ATD0	I-Bit	ATD0CTL2 (ASCIE)	\$D2
\$FFD0, \$FFD1	ATD1	I-Bit	ATD1CTL2 (ASCIE)	\$D0
\$FFCE, \$FFCF	Port J	I-Bit	.PTJIF (PTJIE)	\$CE
\$FFCC, \$FFCD	Port H	I-Bit	PTHIF(PTHIE)	\$CC
\$FFCA, \$FFCB	Modulus Down Counter underflow	I-Bit	MCCTL(MCZI)	\$CA

Fig 8-2: MC9S12DG256 Interrupt vector table 1

\$FFC8, \$FFC9	Pulse Accumulator B Overflow	I-Bit	PBCTL(PBOVI)	\$C8
\$FFC6, \$FFC7	CRG PLL lock	I-Bit	CRGINT(LOCKIE)	\$C6
\$FFC4, \$FFC5	CRG Self Clock Mode	I-Bit	CRGINT (SCMIE)	\$C4
\$FFC2, \$FFC3	BDLC	I-Bit	DLCBCR1(IE)	\$C2
\$FFC0, \$FFC1	IIC Bus	I-Bit	IBCR (IBIE)	\$C0
\$FFBE, \$FFBF	SPI1	I-Bit	SP1CR1 (SPIE, SPTIE)	\$BE
\$FFBC, \$FFBD	SPI2	I-Bit	SP2CR1 (SPIE, SPTIE)	\$BC
\$FFBA, \$FFBB	EEPROM	I-Bit	EECTL(CCIE, CBEIE)	\$BA
\$FFB8, \$FFB9	FLASH	I-Bit	FCTL(CCIE, CBEIE)	\$B8
\$FFB6, \$FFB7	CAN0 wake-up	I-Bit	CAN0RIER (WUPIE)	\$B6
\$FFB4, \$FFB5	CAN0 errors	I-Bit	CAN0RIER (CSCIE, OVRIE)	\$B4
\$FFB2, \$FFB3	CAN0 receive	I-Bit	CAN0RIER (RXFIE)	\$B2
\$FFB0, \$FFB1	CAN0 transmit	I-Bit	CAN0TIER (TXEIE2-TXEIE0)	\$B0
\$FFAE, \$FFAF	CAN1 wake-up	I-Bit	CAN1RIER (WUPIE)	\$AE
\$FFAC, \$FFAD	CAN1 errors	I-Bit	CAN1RIER (CSCIE, OVRIE)	\$AC
\$FFAA, \$FFAB	CAN1 receive	I-Bit	CAN1RIER (RXFIE)	\$AA
\$FFA8, \$FFA9	CAN1 transmit	I-Bit	CAN1TIER (TXEIE2-TXEIE0)	\$A8
\$FFA6, \$FFA7	CAN2 wake-up	I-Bit	CAN2RIER (WUPIE)	\$A6
\$FFA4, \$FFA5	CAN2 errors	I-Bit	CAN2RIER (CSCIE, OVRIE)	\$A4
\$FFA2, \$FFA3	CAN2 receive	I-Bit	CAN2RIER (RXFIE)	\$A2
\$FFA0, \$FFA1	CAN2 transmit	I-Bit	CAN2TIER (TXEIE2-TXEIE0)	\$A0
\$FF9E, \$FF9F	CAN3 wake-up	I-Bit	CAN3RIER (WUPIE)	\$9E
\$FF9C, \$FF9D	CAN3 errors	I-Bit	CAN3RIER (TXEIE2-TXEIE0)	\$9C
\$FF9A, \$FF9B	CAN3 receive	I-Bit	CAN3RIER (RXFIE)	\$9A
\$FF98, \$FF99	CAN3 transmit	I-Bit	CAN3TIER (TXEIE2-TXEIE0)	\$98
\$FF96, \$FF97	CAN4 wake-up	I-Bit	CAN4RIER (WUPIE)	\$96
\$FF94, \$FF95	CAN4 errors	I-Bit	CAN4RIER (CSCIE, OVRIE)	\$94
\$FF92, \$FF93	CAN4 receive	I-Bit	CAN4RIER (RXFIE)	\$92
\$FF90, \$FF91	CAN4 transmit	I-Bit	CAN4TIER (TXEIE2-TXEIE0)	\$90
\$FF8E, \$FF8F	Port P Interrupt	I-Bit	PTPIF (PTPIE)	\$8E
\$FF8C, \$FF8D	PWM Emergency Shutdown	I-Bit	PWMSDN (PWMIE)	\$8C
\$FF80 to \$FF8B	Reserved			

Fig 8-3: MC9S12DG256 Interrupt vector table 2

Interrupt Source	Secondary Vector Address	Interrupt Source	Secondary Vector Address
Reserved \$FF80	\$EF80	I ² C bus	\$EFC0
Reserved \$FF82	\$EF82	DLC	\$EFC2
Reserved \$FF84	\$EF84	SCME	\$EFC4
Reserved \$FF86	\$EF86	CRG lock	\$EFC6
Reserved \$FF88	\$EF88	Pulse accumulator B overflow	\$EFC8
Reserved \$FF8A	\$EF8A	Modulus down counter underflow	\$EFCA
PWM emergency shutdown	\$EF8C	Port H interrupt	\$EFCC
Port P interrupt	\$EF8E	Port J interrupt	\$EFCE
MSCAN 4 transmit	\$EF90	ATD1	\$EFD0
MSCAN 4 receive	\$EF92	ATD0	\$EFD2
MSCAN 4 errors	\$EF94	SCII	\$EFD4
MSCAN 4 wakeup	\$EF96	SCI0	\$EFD6
MSCAN 3 transmit	\$EF98	SPI0	\$EFD8
MSCAN 3 receive	\$EF9A	Pulse accumulator A input edge	\$EFDA
MSCAN 3 errors	\$EF9C	Pulse accumulator A overflow	\$EFDC
MSCAN 3 wakeup	\$EF9E	Timer overflow	\$EFDE
MSCAN 2 transmit	\$EFA0	Timer channel 7	\$EFE0
MSCAN 2 receive	\$EFA2	Timer channel 6	\$EFE2
MSCAN 2 errors	\$EFA4	Timer channel 5	\$EFE4
MSCAN 2 wakeup	\$EFA6	Timer channel 4	\$EFE6
MSCAN 1 transmit	\$EFA8	Timer channel 3	\$EFE8
MSCAN 1 receive	\$EFAA	Timer channel 2	\$EFEA
MSCAN 1 errors	\$EFAC	Timer channel 1	\$EFEC
MSCAN 1 wakeup	\$EFAE	Timer channel 0	\$EFEE
MSCAN 0 transmit	\$EFB0	Real-time interrupt	\$EFF0
MSCAN 0 receive	\$EFB2	IRQ	\$EFF2
MSCAN 0 errors	\$EFB4	XIRQ	\$EFF4
MSCAN 0 wakeup	\$EFB6	SWI	\$EFF6
FLASH	\$EFB8	Unimplemented instruction trap	\$EFF8
EEPROM	\$EFBA	COP failure reset	\$EFFA
SPI2	\$EFBC	Clock monitor fail reset	\$EFFC
SPI1	\$EFBE	Reset	\$EFFE

Fig 8-4: MC9S12DG256 secondary interrupt vector table

8.3 Useful web links

The web is the best source for getting more information about the HCS12. The Freescale web site has all documents and application notes that you need.

The HC12 user group <http://groups.yahoo.com/group/68HC12/> and Freescale's forums <http://forums.freescale.com/freescale/> are good places to ask a question and get a prompt answer from many other HC12 users.

You also can visit our web site at:

http://www.evbplus.com/hc11_68hc11_hc12_68hc12_9s12_hcs12_sites.html

to get links to many university web sites that offer course materials and lab assignments for the Dragon12 and Dragon12-Plus boards.

All HCS12 boards that are pre-loaded with Freescale serial monitor, bootloader and D-Bug12 monitor on the market today are basically the same products as far as software development is concerned. If you are going to use a BDM to debug a HCS12 board, all HCS12 boards will respond to all BDM commands in the same manner because the BDM directly communicates with the MC9S12DG256 MCU. The information on our manual can apply to the boards from other manufacturers, and vice versa.

8.4 Troubleshooting notes

The following are some important notes that you should know and they may save you time:

1. Things to do if the board does not work.

Many little mistakes can cause a big problem, especially for beginners. For instance, if you want to run the board in single chip mode, but MODEB, A, and C are set for expanded mode, you know it won't work. If the jumper on J1 is missing, the LCD backlight won't work and if the jumper on J24 is missing, the 7-segment display won't be lit.

Before troubleshooting the board, you must apply power to the board. When the board is powered, the PWR LED indicator must be on. If it's off, the board does not have 5V DC. Sometimes it may be caused by a bad AC adapter or the AC adapter may not even be plugged in.

To determine if the board malfunctions, you can restore the following jumper settings to the original default settings when you receive the board. The default settings are as follows:

J1	Enables the LCD backlight, Jumper is installed.
J3	No jumper
J18	VCC for H-bridge, U12, SN754410N. No jumper.
J23	SCI1 receiver select, jumper is set for IR (in the "bottom" position)
J24	7-segment_EN, jumper is on
J25	DC motor power select. Jumper is placed in the "up" position.
J26	Speaker driving source. Jumper is placed in the "top" position (driven by PT5)
J27	IR select, both jumpers are placed in the "up" positions
J29	SCI1 receiver select, no jumper
J35	Servo motor power select, jumper is placed in the "left" position.
SW7	MODE select, both DIP switches of SW7 are set in the "low" positions for EVB mode.

If all above settings are correct and you press the reset button, the PB0-PB7 LEDs should light up from left to right one at a time and the LCD should display the following message:

**“DRAGON12plus EVB”
“D-Bug12 EVB MODE”**

If the LEDs lighted up and the LCD displays the following message:

**“DRAGON12plus EVB”
“ D-Bug12 ERASED ” or “RUN USER PROGRAM” or “*****”**

then the D-Bug12 monitor is erased. You can re-program the D-Bug12 in bootloader mode according the instructions on page 19. If the board does not communicate with the PC, the COM port number may not be set correctly by AsmIDE. If the screen displays some garbled characters, the baud rate may not be set correctly. The D-Bug12 resets the baud rate to 9600 during power up, if you changed the baud, you must change the AsmIDE's baud rate to the same baud.

If the PB0-PB7 LEDs don't light up from left to right one at a time, the bootloader could be erased by a BDM. You can use a BDM with instructions from the manufacturer or use another Dragon12 Plus board as a BDM POD to re-program bootloader and D-Bug12 monitor into flash memory according to the instructions on page 16.

The newest firmware can be downloaded at: www.evbplus.com/download_hcs12.html

2. Always reset the board before downloading a new program.

If the previous application program that you ran was aborted, then you may need to reset the board before downloading a new application program. The reset action will disable the interrupt that was enabled by the previous application. If the interrupt was caused by a timer and is not disabled, the timer interrupt will continue even it's not called for in your new application program. The result will be unpredictable.

3. In EVB mode, reset clears your pseudo RAM interrupt vectors.

When you develop code with interrupts in RAM, you must initialize pseudo RAM interrupt vectors in the very beginning of your program, because if you press the reset button it will clear all pseudo RAM interrupt vectors. If you don't initialize pseudo RAM interrupt vectors in your program and your application program uses interrupts, your program may not run correctly since the interrupt vectors do not exist.

4. Operating mode changing is only effective after reset.

There are four operating modes that are selected by SW7. The mode change won't be effective until you reset the board. So you must always press the reset button after a mode change.

8.5 Revision History

Date	Rev. #	Notes
04/18/07	A	Prototype
06/30/07	B	<p>First batch of production boards.</p> <ol style="list-style-type: none"> The external resistor network (RN12) for port A on the original Dragon12 board is eliminated on the new Dragon12-plus board. In order for keypad routine to work with the new Dragon12-Plus board, the internal pull-up resistors for port A must be enabled by adding the following instruction at the beginning of your program source code: <pre>bset pucr,1 ; enable pull-up resistors on port A</pre> The PB0-PB7 LEDs on the original Dragon12 board prior to rev. E board are driven by port B only, but they are also controlled by PJ1 on the new Dragon12-plus board. In order to turn on PB0-PB7 LEDs on the new Dragon12-Plus board, the PJ1 (pin 21 of MC9S12DG256) must be programmed as output and set for logic zero.
09/05/07	C	<ol style="list-style-type: none"> Eliminated low battery detection circuit for easy manufacturing. Eliminated VR1 footprint for easy manufacturing. Eliminated U4, U17 footprints for preventing solder bridges. Eliminated J24B (LED_EN) and rename J24A (7SEG_EN) to J24. The headers J20(BDM-IN) and J21(BDM-OUT) are rotated by 90 degrees for easy manufacturing. Added footprint of a LPF (R12 and C26) for RF receiver. C37,C38,C39,C40,C41,C42,C43,C44,C45,J28 and J29 are not installed since they are not used by standard features. RN11 is not installed and it's replaced by internal pull-up resistors.
09/26/07	D	<p>Same as rev C board except:</p> <ol style="list-style-type: none"> LCD module is hardwired for write-only operation. Experienced user can cut a trace between pin 2 and pin 3 of J5 on solder side, then install a 3-pin male header on J5 to make it for both read and write operations. Locations of J1 and J5 are swapped for easy manufacturing. Corrected the misprinted label PT6 to PT5 for J26.
06/01/08	E	Designed for a special customer and was never sold to public.
10/06/08	F	<p>Same as rev D board except:</p> <ol style="list-style-type: none"> Most discrete components, such as resistors, capacitors, diodes, transistors and LEDs are changed to SMD. The temperature sensor is changed from MCP9701A (U14) to LM45 (U14A). Both are the same type of sensors with analog voltage outputs, but with different sensitivities. The MCP9701A outputs 19.5mV per degree C while the LM45 outputs 10mV per degree C.